



BUSSOLE PORTA BARENO BORING BAR SLEEVES



BUSSOLE PORTA BARENO PER TORNI CNC.



BORING BAR HOLDING BUSHINGS FOR CNC LATHES.



CHIA-MO SRL
VIA CADUTI DI SABBIBUONO, 12
40011 ANZOLA DELL'EMILIA
BOLOGNA ITALY

TEL +39 051734153
FAX +39 051734958

WWW.CHIAMO.IT
INFO@CHIAMO.IT



BUSSOLE P.BARENI DOPPIO FORO CON GRANI

BORING BAR SLEEVES

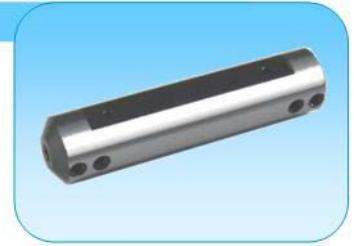

ART. (Code)	D	d1	d2	L
241.1245 075	12	4	5	75
241.1645 075	16	4	5	75
241.1667 090	16	6	7	90
241.1668 090	16	6	8	90
241.2045 090	20	4	5	90
241.2067 090	20	6	7	90
241.2068 090	20	6	8	90

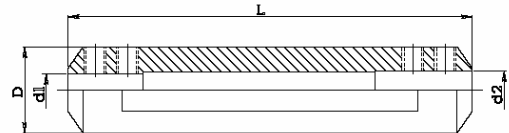

BUSSOLE P.BARENI CON GRANI

BORING BAR SLEEVES

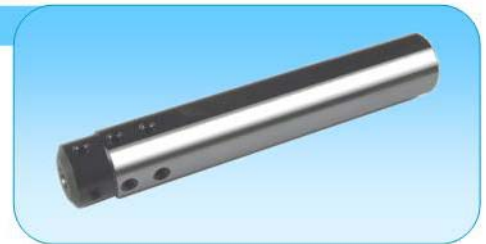

ART. (Code)	D	d1	L
241.1604 100	16	4	100
241.1605 100	16	5	100
241.1606 100	16	6	100
241.1607 100	16	7	100
241.2004 100	20	4	100
241.2005 100	20	5	100
241.2006 100	20	6	100
241.2007 100	20	7	100
241.2008 100	20	8	100

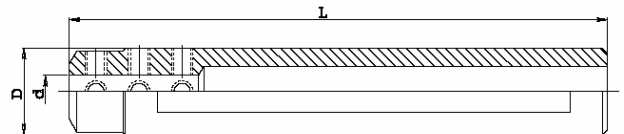



BUSSOLE P. BARENI CON GRANI E BATTUTA Tipo 243

BORING BAR SLEEVES

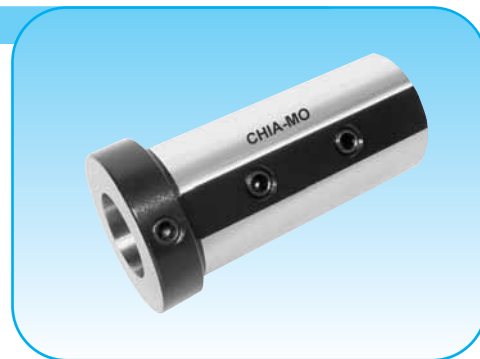
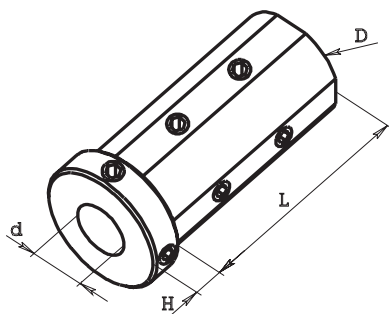

BUSSOLE DIAMETRO 19,05 DIAMETER 19,05 BUSHES

ART. (Code)	D	d	H	L
243.1906 050	19,05	6	5	50
243.1908 050	19,05	8	5	50
243.1910 050	19,05	10	5	50

BUSSOLE DIAMETRO 20 DIAMETER 20 BUSHES

ART. (Code)	D	d	H	L
243.2006 050	20	6	5	50
243.2008 050	20	8	5	50
243.2010 050	20	10	5	50

BUSSOLE DIAMETRO 22 DIAMETER 22 BUSHES

ART. (Code)	D	d	H	L
243.2206 054	22	6	6	54
243.2208 054	22	8	6	54
243.2210 054	22	10	6	54

BUSSOLE DIAMETRO 25 DIAMETER 25 BUSHES

ART. (Code)	D	d	H	L
243.2506 054	25	6	6	54
243.2508 054	25	8	6	54
243.2510 054	25	10	6	54
243.2512 054	25	12	6	54

BUSSOLE DIAMETRO 25,40 DIAMETER 25,40 BUSHES

ART. (Code)	D	d	H	L
243.2606 054	25,4	6	6	54
243.2608 054	25,4	8	6	54
243.2610 054	25,4	10	6	54
243.2612 054	25,4	12	6	54

BUSSOLE DIAMETRO 31,75 DIAMETER 31,75 BUSHES

ART. (Code)	D	d	H	L
243.3106 063	31,75	6	7	63
243.3108 063	31,75	8	7	63
243.3110 063	31,75	10	7	63
243.3112 063	31,75	12	7	63
243.3114 063	31,75	14	7	63
243.3116 063	31,75	16	7	63
243.3120 063	31,75	20	7	63

BUSSOLE DIAMETRO 32 DIAMETER 32 BUSHES

ART. (Code)	D	d	H	L
243.3208 040	32	8	7	40
243.3210 040	32	10	7	40
243.3212 040	32	12	7	40
243.3216 040	32	16	7	40
243.3220 040	32	20	7	40
243.3206 063	32	6	7	63
243.3208 063	32	8	7	63
243.3210 063	32	10	7	63
243.3212 063	32	12	7	63
243.3214 063	32	14	7	63
243.3216 063	32	16	7	63
243.3220 063	32	20	7	63

BUSSOLE DIAMETRO 40 DIAMETER 40 BUSHES

ART. (Code)	D	d	H	L
243.4006 070	40	6	12	70
243.4008 080	40	8	12	80
243.4010 080	40	10	12	80
243.4012 080	40	12	12	80
243.4014 080	40	14	12	80
243.4016 080	40	16	12	80
243.4018 080	40	18	12	80
243.4020 080	40	20	12	80
243.4025 080	40	25	12	80

BUSSOLE DIAMETRO 50 DIAMETER 50 BUSHES

ART. (Code)	D	d	H	L
243.5010 085	50	10	12	85
243.5012 085	50	12	12	85
243.5016 085	50	16	12	85
243.5020 085	50	20	12	85
243.5025 085	50	25	12	85
243.5032 085	50	32	12	85

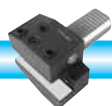

**BUSSOLE P. BARENI CON ASOLA, GRANO E BATTUTA Tipo 244**

BORING BAR SLEEVES

BUSSOLE DIAMETRO 20 DIAMETER 20 BUSHES

ART. (Code)	D	d	H	L
244.2010 050	20	10	8	50
244.2012 050	20	12	8	50
244.2016 050	20	16	8	50

BUSSOLE DIAMETRO 22 DIAMETER 22 BUSHES

ART. (Code)	D	d	H	L
244.2212 054	22	12	8	54
244.2216 054	22	16	8	54

BUSSOLE DIAMETRO 25 DIAMETER 25 BUSHES

ART. (Code)	D	d	H	L
244.2514 055	25	14	12	55
244.2516 055	25	16	12	55
244.2520 055	25	20	12	55

BUSSOLE DIAMETRO 25,40 DIAMETER 25,40 BUSHES

ART. (Code)	D	d	H	L
244.2614 055	25,4	14	12	55
244.2616 055	25,4	16	12	55
244.2619 055	25,4	19,05	12	55
244.2620 055	25,4	20	12	55

BUSSOLE DIAMETRO 31,75 DIAMETER 31,75 BUSHES

ART. (Code)	D	d	H	L
244.3125 065	31,75	25	12	65

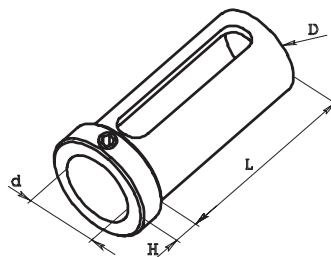
**BUSSOLE DIAMETRO 32 DIAMETER 32 BUSHES**

ART. (Code)	D	d	H	L
244.3220 065	32	20	12	65
244.3225 065	32	25	12	65

BUSSOLE DIAMETRO 40 DIAMETER 40 BUSHES

ART. (Code)	D	d	H	L
244.4016 080	40	16	12	80
244.4020 080	40	20	12	80
244.4025 080	40	25	12	80
244.4032 089	40	32	12	89

BUSSOLE DIAMETRO 50 DIAMETER 50 BUSHES

ART. (Code)	D	d	H	L
244.5025 085	50	25	12	85
244.5032 085	50	32	12	85
244.5040 088	50	40	12	88

BUSSOLE P. BARENI CON ASOLA E BATTUTA Tipo 245

BORING BAR SLEEVES

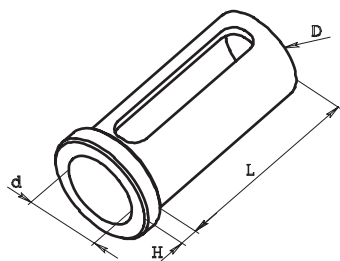
**BUSSOLE DIAMETRO 19,05 DIAMETER 19,05 BUSHES**

ART. (Code)	D	d	H	L
245.1912 050	19,05	12	6	50
245.1914 050	19,05	14	6	50
245.1916 050	19,05	16	6	50

BUSSOLE DIAMETRO 20 DIAMETER 20 BUSHES

ART. (Code)	D	d	H	L
245.2008 030	20	8	6	30
245.2010 030	20	10	6	30
245.2012 030	20	12	6	30
245.2014 030	20	14	6	30
245.2006 040	20	6	6	40
245.2008 040	20	8	6	40
245.2010 040	20	10	6	40
245.2012 040	20	12	6	40
245.2016 040	20	16	6	40
245.2012 050	20	12	6	50
245.2014 050	20	14	6	50
245.2016 050	20	16	6	50

BUSSOLE DIAMETRO 25 DIAMETER 25 BUSHES

ART. (Code)	D	d	H	L
245.2508 050	25	8	6	50
245.2510 050	25	10	6	50
245.2512 050	25	12	6	50
245.2514 050	25	14	6	50
245.2516 050	25	16	6	50
245.2518 050	25	18	6	50
245.2520 050	25	20	6	50

BUSSOLE DIAMETRO 31,75 DIAMETER 31,75 BUSHES

ART. (Code)	D	d	H	L
245.3108 062	31,75	8	6	62
245.3110 062	31,75	10	6	62
245.3112 062	31,75	12	6	62
245.3114 062	31,75	14	6	62
245.3116 062	31,75	16	6	62
245.3118 062	31,75	18	6	62
245.3120 062	31,75	20	6	62
245.3125 062	31,75	25	6	62
245.3126 062	31,75	25,4	6	62

BUSSOLE DIAMETRO 32 DIAMETER 32 BUSHES

ART. (Code)	D	d	H	L
245.3208 062	32	8	6	62
245.3210 062	32	10	6	62
245.3212 062	32	12	6	62
245.3214 062	32	14	6	62
245.3216 062	32	16	6	62
245.3218 062	32	18	6	62
245.3220 062	32	20	6	62
245.3225 040	32	25	7	40
245.3225 062	32	25	6	62
245.3226 062	32	25,4	6	62

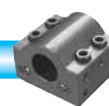
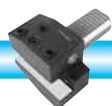



BUSOLE P. BARENI CON GRANI SENZA BATTUTA Tipo 246

BORING BAR SLEEVES

BUSOLE DIAMETRO 25 DIAMETER 25 BUSHES

ART. (Code)	D	d	L
246.2506 050	25	6	50
246.2508 050	25	8	50
246.2510 050	25	10	50
246.2512 050	25	12	50
246.2514 050	25	14	50
246.2516 050	25	16	50



BUSOLE DIAMETRO 31,75 DIAMETER 31,75 BUSHES

ART. (Code)	D	d	L
246.3108 060	31,75	8	60
246.3110 060	31,75	10	60
246.3112 060	31,75	12	60
246.3114 060	31,75	14	60
246.3116 060	31,75	16	60
246.3118 060	31,75	18	60
246.3120 060	31,75	20	60

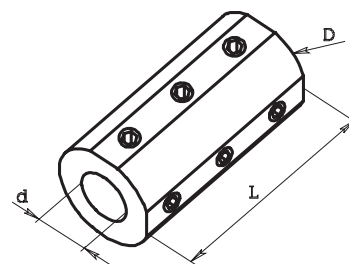

BUSOLE DIAMETRO 32 DIAMETER 32 BUSHES

ART. (Code)	D	d	L
246.3208 060	32	8	60
246.3210 060	32	10	60
246.3212 060	32	12	60
246.3214 060	32	14	60
246.3216 060	32	16	60
246.3218 060	32	18	60
246.3220 060	32	20	60

BUSOLE DIAMETRO 40 DIAMETER 40 BUSHES

ART. (Code)	D	d	L
246.4008 080	40	8	80
246.4010 080	40	10	80
246.4012 080	40	12	80
246.4016 080	40	16	80

BUSOLE P. BARENI CON ASOLA SENZA BATTUTA Tipo 247

BORING BAR SLEEVES

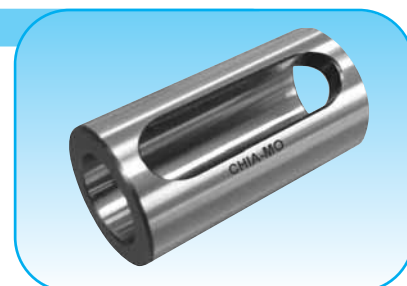
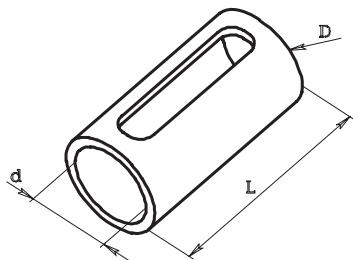

BUSOLE DIAMETRO 25 DIAMETER 25 BUSHES

ART. (Code)	D	d	L
247.2508 050	25	8	50
247.2510 050	25	10	50
247.2512 050	25	12	50
247.2514 050	25	14	50
247.2516 050	25	16	50
247.2518 050	25	18	50
247.2520 050	25	20	50

BUSOLE DIAMETRO 32 DIAMETER 32 BUSHES

ART. (Code)	D	d	L
247.3208 060	32	8	60
247.3210 060	32	10	60
247.3212 060	32	12	60
247.3214 060	32	14	60
247.3216 060	32	16	60
247.3220 060	32	20	60
247.3225 060	32	25	60

BUSOLE DIAMETRO 31,75 DIAMETER 31,75 BUSHES

ART. (Code)	D	d	L
247.3108 060	31,75	8	60
247.3110 060	31,75	10	60
247.3112 060	31,75	12	60
247.3114 060	31,75	14	60
247.3116 060	31,75	16	60
247.3120 060	31,75	18	60
247.3125 060	31,75	20	60

BUSOLE DIAMETRO 40 DIAMETER 40 BUSHES

ART. (Code)	D	d	L
247.4020 080	40	20	80
247.4025 080	40	25	80
247.4032 080	40	32	80

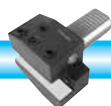



BUSOLE CORTE CON FORO Tipo 248

BORING BAR SLEEVES

Code					
ART.	D	d	H	L	fig.
248.4016 053	40	16	7	53	1
248.4020 053	40	20	7	53	1
248.4025 053	40	25	7	53	1
248.4032 053	40	32	7	53	1

Code						
ART.	D	d	H	L	I	fig.
248.5016 050	50	16	12	50	25	2
248.5020 050	50	20	12	50	25	2
248.5025 050	50	25	12	50	25	2
248.5032 050	50	32	12	50	25	2
248.5040 050	50	40	12	50	25	2

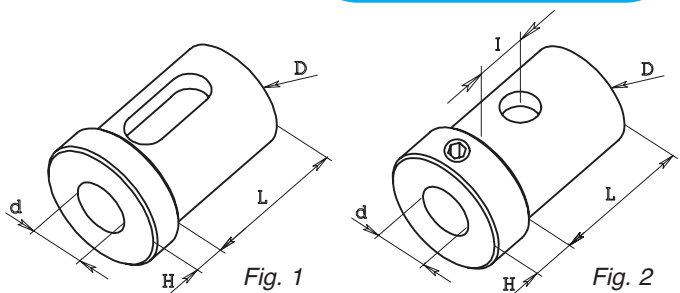
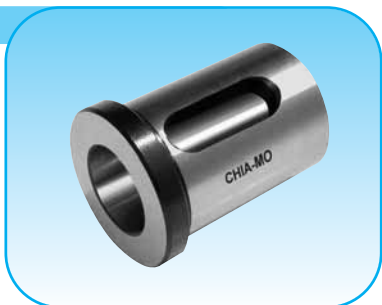

BUSOLE PORTA BARENI CON FORI Tipo 248

BORING BAR SLEEVES

Code						
ART.	D	d	L	H	I	P
248.4020 089	40	20	89	7	10	33
248.4025 089	40	25	89	7	10	33
248.4032 089	40	32	89	7	10	33

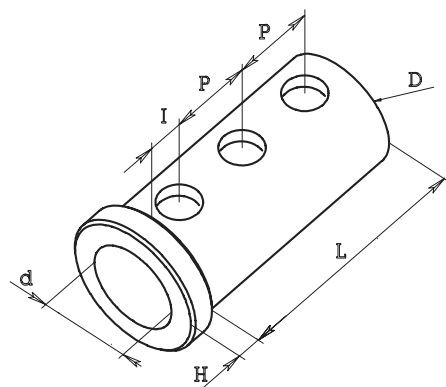

BUSOLE PORTA BARENI PROLUNGATE Tipo 249

BORING BAR SLEEVES

Code				
ART.	D	d	L	H
249.3206 070	32	6	70	27
249.3208 070	32	8	70	27
249.3210 070	32	10	70	27
249.3212 070	32	12	70	27
249.3216 070	32	16	70	27
249.3220 070	32	20	70	27



Code				
ART.	D	d	L	H
249.4008 089	40	8	89	40
249.4010 089	40	10	89	40
249.4012.089	40	12	89	40
249.4016 089	40	16	89	40
249.4020 089	40	20	89	40
249.4025 089	40	25	89	40

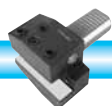
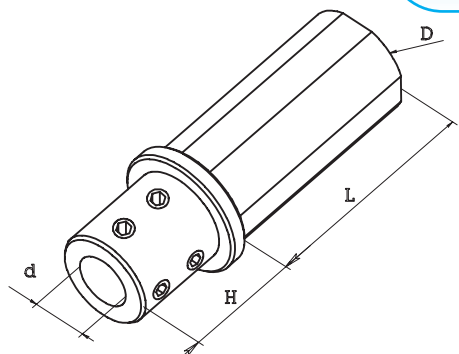



BUSOLE PORTA BARENI Tipo 248

BORING BAR SLEEVES

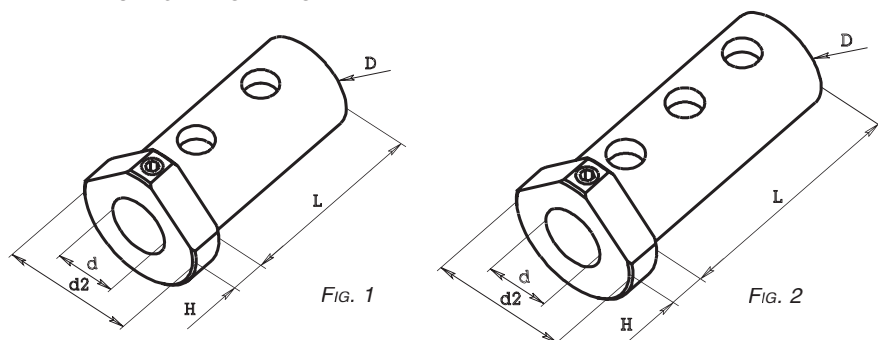

Per macchina (for machine) : MURATA MW 12 G

Code						Hole diameter	Distance between holes	
ART.	D	d	d2	H	L	diametro fori	interasse fori	fig.
248.4016 080	40	16	54.6	15	80	15	50	1
248.4020 080	40	20	54.6	15	80	15	50	1
248.4025 080	40	25	54.6	15	80	15	50	1
248.4032 080	40	32	54.6	15	80	15	50	1

Per macchina (for machine) : MURATA MW 20 G

ART.	D	d	d2	H	L	diametro fori	interasse fori	fig.
248.4016 105	40	16	54.6	15	105	16	37.5	2
248.4020 105	40	20	54.6	15	105	16	37.5	2
248.4025 105	40	25	54.6	15	105	16	37.5	2
248.4032 105	40	32	54.6	15	105	16	37.5	2
248.5040 094	50	40	58	15	94	14	45	1

CANOTTI PER TORNI PLURIMANDRINO

MULTISPINDLE BUSHES

Code				MT
ART.	d	H	L	cono morse
150.232P	32	—	160	C.M.2
150.238P	38.10	—	160	C.M.2
150.240P	40	—	170	C.M.2
150.244P	44.45	—	170	C.M.2
150.250P	50	—	170	C.M.2
150.251P	50.80	—	170	C.M.2
150.332P	32	—	160	C.M.3
150.338P	38.10	—	160	C.M.3
150.340P	40	—	170	C.M.3
150.344P	44.45	—	170	C.M.3
150.350P	50	—	170	C.M.3
150.351P	50.80	—	170	C.M.3
150.360P	60	—	180	C.M.3
150.363P	63.50	—	180	C.M.3
150.438P	38.10	—	160	C.M.4
150.440P	40	—	170	C.M.4
150.444P	44.45	—	170	C.M.4
150.450P	50	—	170	C.M.4
150.451P	50.80	—	170	C.M.4
150.460P	60	—	180	C.M.4
150.463P	63.50	—	180	C.M.4

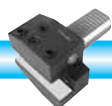
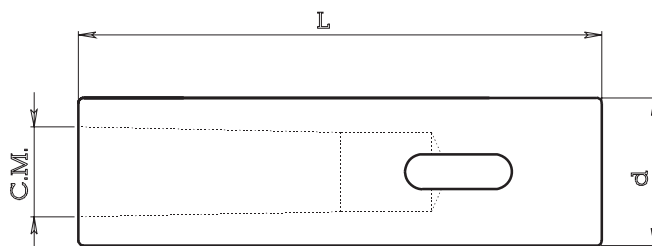



BUSSOLE PER CONO MORSE Tipo 150 e 243
MORSE TAPER BUSHES

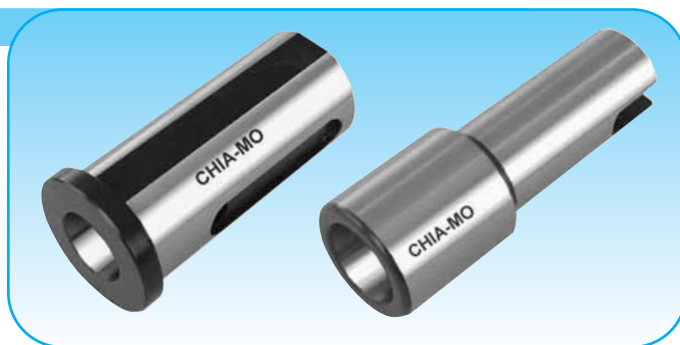

Code					
ART.	D	C.M.	H	L	Fig.
150.119	19.05	1	--	63	2
150.219	19.05	2	29	46	1
150.120	20	1	--	63	2
150.220	20	2	29	46	1
150.122	22	1	--	63	2
150.222	22	2	25	50	1
150.125	25	1	--	63	2
150.225	25	2	--	75	2
150.325	25	3	54	46	1
150.126	25.40	1	--	63	2
150.226	25.40	2	--	75	2
150.326	25.40	3	54	46	1
150.130	30	1	--	63	2
150.230	30	2	--	75	2
150.330	30	3	--	100	2
150.131	31,75	1	--	63	2
150.231	31,75	2	--	75	2
150.331	31,75	3	--	100	2
150.132	32	1	--	63	2
150.232	32	2	--	75	2
150.332	32	3	--	100	2

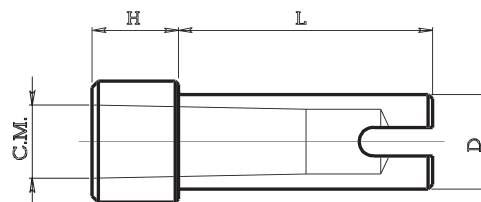

Fig. 1

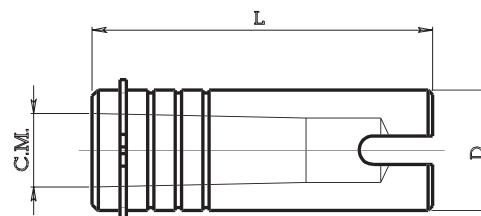

Fig. 2

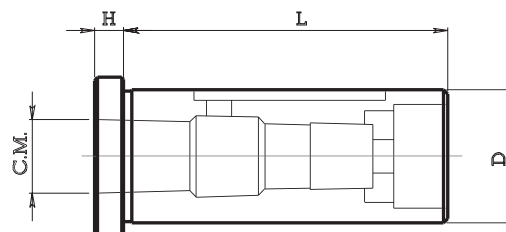
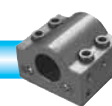
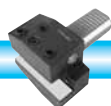

Fig. 3

ART.	D	C.M.	H	L	Fig.
243.2503	25	3	54	55	3
243.3102	31,75	2	7	78	3
243.3103	31,75	3	16	78	3
243.3201	32	1	7	70	3
243.3202	32	2	7	78	3
243.3203	32	3	16	78	3
243.4001	40	1	7	70	3
243.4002	40	2	7	89	3
243.4003	40	3	7	89	3
243.4004	40	4	29	89	3
243.5004	50	4	30	90	3





BUSSELE PORTA PINZA CON GHIERA INTERNA

BUSH (CYLINDRICAL CONNECTION)

Code					Collet	Collet code	Nut code	Spanner code
ART.	D	H	L	X	Pinza	Art. pinza	Art. ghiera	Art. chiave
168.132 070	32	5	70	0.5 - 13	ERC 20	050.020	052.420	053.420
168.240 080	40	5	80	0.5 - 16	ERC 25	050.025	052.425	053.425

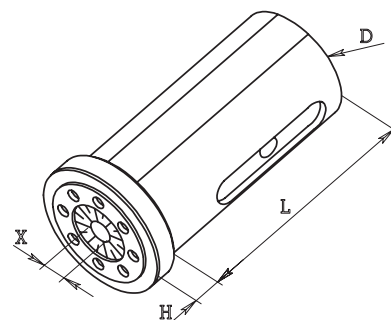

Con passaggio liquido refrigerante dall'interno
With inner coolant feeding system

ADATTATORI PER CODOLI Tipo 242

BUSH (CYLINDRICAL CONNECTION)

Code			
ART.	d	D	L
242.115	15.875	19.05	46
242.116	16	19.05	46
242.219	19.05	22	46
242.220	20	22	46
242.319	19.05	25	46
242.320	20	25	46
242.322	22	25	46
242.415	15.875	25.40	46
242.416	16	25.40	46
242.419	19.05	25.40	46
242.420	20	25.40	46
242.422	22	25.40	46
242.522	22	30	46
242.525	25	30	46
242.526	25.40	30	46
242.622	22	31.75	46
242.625	25	31.75	46
242.626	25.40	31.75	46
242.722	22	32	46
242.725	25	32	46
242.726	25.40	32	46

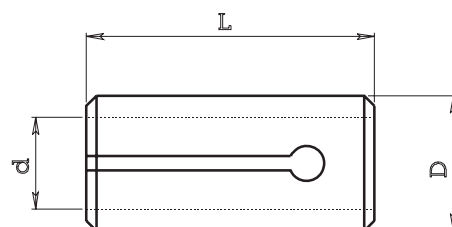
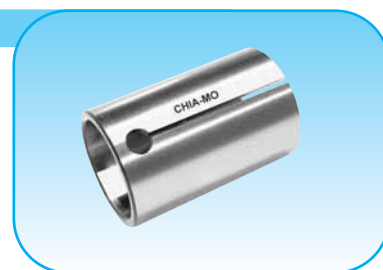

BOCCOLA Tipo 242

BUSH

Code			
ART.	d	D	L
242.901	25,4	37	26

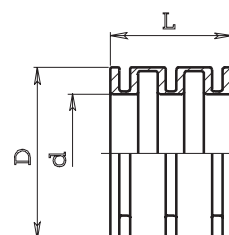

Per bloccaggio porta utensili su macchine Index E 42-60
For tighten up toolholders on Index E 42-60 machines

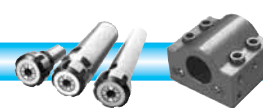
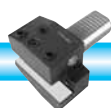

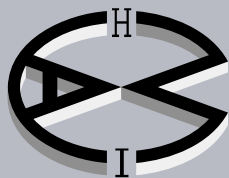

CHIA-MO



DOVE SIAMO WHERE WE ARE



CHIA-MO

Via Caduti di Sabbiuno, 12

40011 Anzola dell'Emilia (Bologna) Italy

Tel. +39 051 734153 - Fax +39 051 734958

info@chiamo.it - www.chiamo.it

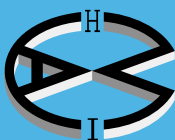

CHIA-MO
ITALY



Via Caduti di Sabbiuono, 12
40011 Anzola dell'Emilia (Bologna) Italy
Tel. +39 051 734153 - Fax +39 051 734958
info@chiamo.it - www.chiamo.it

