

# Magnetboremaskiner

HAJO TOOL



Hajo Tool A/S - markedets bredeste program

# INDHOLDFORTEGNELSE

		<i>Beskrivelse:</i>	<i>Side:</i>
Magnetboremaskine	Fuldauto	Magnetboremaskinen til dit behov .....	Side 3
		QA6500 Magnetboremaskine .....	Side 4
		QA4000 Magnetboremaskine .....	Side 6
	Halvauto	WA5000 Magnetboremaskine .....	Side 8
		WA3500 Magnetboremaskine .....	Side 10
	Manuelle	A05575 Magnetboremaskine .....	Side 12
		WOJ3200 Magnetboremaskine.....	Side 14
		HA3200 Magnetboremaskine .....	Side 16
		AV 32 Magnetboremaskine.....	Side 18
		AV32/50RQ Magnetboremaskine.....	Side 20
A40RQ Magnetboremaskine .....		Side 22	
A40RL-E Magnetboremaskine .....		Side 24	
A60-2 Magnetboremaskine .....		Side 26	
A60RL-E Magnetboremaskine .....		Side 28	
A100 Magnetboremaskine.....		Side 30	
A100RL-E Magnetboremaskine .....	Side 32		
M100/M320 Atra Master .....	Side 34		
Hulsave	HSS &HM	Skæretabel hulsave .....	Side 35
		Hajo Highspeed hulsave SHHS .....	Side 36
		Hajo Highspeed hulsave SHHS .....	Side 37
		Nitto Hibroach HSS hulsave NHHS.....	Side 38
		Hajo Universal pladehulsave MY278U .....	Side 39
		Nitto Jetbroach hulsave NJET.....	Side 40
Nitto Jetbroach hulsave NJET.....	Side 41		
Diverse		Vakuumstander.....	Side 42

## Vælg den bedste magnetboremaskine til dit behov:

Kap.Ø mm min. - max.		Kapacitet mm pladetykkelse min. - max.		Vægt	Watt	Højre / Venstre	Total højde mm	Automatisk Tilspænding.	Spindel- fæste.	Spiralbor mm	Vare nummer
3mm	32mm	6mm	50mm	11 kg	1050	Nej	410 <sup>1</sup>	NEJ	Weldon 19mm	13 mm	N1HA3200
12mm	55mm	9mm	75mm	18 kg	1150	Nej	545 <sup>2</sup>	NEJ	Lyn-bajonet	NEJ	N1A05575
3mm	32mm	9mm	50mm	13 kg	950	Nej	385 <sup>2</sup>	NEJ	Lyn-bajonet	13 mm	N1W0J3200
14mm	35mm	9mm	35mm	20 kg	1100	Nej	495 <sup>2</sup>	JA	Lyn-bajonet	NEJ	N1WA3500
14mm	50mm	9mm	75mm	23 kg	1150	Nej	545 <sup>2</sup>	JA	Lyn-bajonet	NEJ	N1WA5000
14mm	40mm	9mm	35mm	19 kg	680	Nej	410 <sup>2</sup>	JA	Lyn-bajonet	NEJ	N1QA4000
17,5	65mm	9mm	50mm	26 kg	1010	Nej	500 <sup>2</sup>	JA	Lyn-bajonet	NEJ	N1QA6500
12mm	32mm	6mm	32mm	13 kg	900	Nej	200 <sup>3</sup>	NEJ	Weldon 19mm	NEJ	AV32
3mm	32mm	9mm	35mm	11 kg	900	Nej	410 <sup>1</sup>	NEJ	Lyn-bajonet	13 mm	A32RQ
3mm	32mm	6mm	50mm	11 kg	1050	Nej	410 <sup>1</sup>	NEJ	Lyn-bajonet	13 mm	A32/50RQ
3mm	40mm	10mm	50mm	16 kg	1200	Nej	415 <sup>1</sup>	NEJ	Lyn-bajonet	13 mm	A40RQ
3mm	40mm	10mm	50mm	16 kg	1200	Ja	490 <sup>5</sup>	NEJ	MK2	20 mm	A40RLE
3mm	60mm	10mm	50mm	22 kg	1800	Nej	1	NEJ	Weldon 19mm	13 mm	A60-2
3mm	60mm	10mm	50mm	22 kg	1800	Ja	4	NEJ	MK3	32 mm	A60RLE
3mm	100mm	10mm	50mm	28 kg	1800	Nej	540 <sup>4</sup>	NEJ	MK3	32 mm	A100
3mm	100mm	10mm	50mm	28 kg	1800	Ja	540 <sup>4</sup>	NEJ	MK3	32 mm	A100RLE
Magnetborestandere m/boremaskine monteret:											
3mm	10mm	6mm	20mm	9 kg	650	Ja	385	NEJ	Borepatron	10 mm	N1100
3mm	100mm 150mm	10mm	100mm 50mm	54 kg	1700	Ja	(800)	NEJ	MK4	50mm	N11320

Ved gevindskæring er bedste valg en højre/venstre maskine.

- OBS!** <sup>1</sup> Mindste højde med monteret Ø12 mm hulsav f/25mm pladetykkelse type SHHS2512 (uden centerspids).  
<sup>2</sup> Mindste højde med monteret Ø17,5 mm hulsav f/35mm pladetykkelse type NJET35175 (uden centerspids).  
<sup>3</sup> Mindste højde uden bæregreb.  
<sup>4</sup> Mindste højde med lynbajonet MK3 holder + Ø12 mm hulsav f/25mm pladetykkelse type SHHS2512 (uden centerspids).  
<sup>5</sup> Mindste højde med lynbajonet MK2 holder + Ø12 mm hulsav f/25mm pladetykkelse type SHHS2512 (uden centerspids).

Hvorfor vælge en magnetboremaskine med automatisk tilspænding ?	Hvornår vælger man en manuel magnetboremaskine?
<b>Fordi:</b> <ol style="list-style-type: none"> <li>1. Man sparer mange hulsave, på grund af tilspændings teknikken !</li> <li>2. Magnetboremaskinen arbejder alene !</li> <li>3. Den arbejder hurtigere end dig, .... hvis du må nøjes med en manuel maskine !</li> </ol>	<b>Når:</b> <ol style="list-style-type: none"> <li>1. Man ønsker, at bruge spiralbor !</li> <li>2. Man vil skære gevind !</li> <li>3. Antallet af huller er begrænset !</li> <li>4. Man har specialopgaver !</li> <li>5. Vægten skal være lav !</li> </ol>

# QA6500 MAGNETBOREMASKINE

## NITTO fuldautomatisk boremaskine

- med dobbelt sensor system og ONE-TOUCH lyn-bajonet system.

**FULDAUTOMATISK**



HAJO Varenummer: N1QA6500

### Data:

Max. kap. hulsav:	Ø 65 x 50 mm
Optagen effekt:	1.010 watt
Omdr./min ubelast.:	400 / 750*
Mål (L)x(H)x(B) mm:	455 x 535 x 215
Magnetholdekraft:	1.000 Kg
Magnetfod mm:	100 x 200
Lyn-bajonet system:	JA / ONE-TOUCH
Integreret smøring:	JA
Vægt:	26 Kg

- \*Fuldautomatisk maskine med dobbelt sensor system der kontrollerer tilspændings- og rotations hastighed.
- Auto-return som returnerer boret til start position.
- Fingertouch start / stop.
- Automatisk overbelastnings system
- Dobbelt rullejesty.

## NITTO HIBROACH hulsave korte:

NITTO ONE-TOUCH HULSAVE HIBROACH  
Ø 18 - 52 mm i en skæredybde på 25 mm

HAJO varenummer: **NHHS25xx**



## NITTO HIBROACH hulsave lange:

NITTO ONE-TOUCH HULSAVE HIBROACH  
Ø 18 - 52 mm i en skæredybde på 50 mm

HAJO varenummer: **NHHS50xx**



## NITTO Centerspids for NHHS

Tilhørende centerspids for NHHS Ø 18 - 52 mm.  
Ø 8 x 91 mm HAJO varenummer: **NHHS250891**



## NITTO Centerspids for NHHS

Tilhørende centerspids for NHHS Ø 18  
Ø 6 x 102 mm HAJO varenummer: **NHHS5006102**



Tilhørende centerspids for NHHS Ø 19 - 52 mm:  
Ø 8 x 102 mm HAJO varenummer: **NHHS5008102**

### Leverandør info:

HAJO TOOL A/S  
Vejlegårdsvej 65B  
2665 Vallensbæk Strand

Telefon: 44 44 24 00  
Fax: 44 44 08 33  
Web: www.hajo.dk



Tilbehør se ----->

A



# QA6500 MAGNETBOREMASKINE

## TILBEHØR / INFO

### NITTO JETBROACH hulsave korte: ONE-TOUCH / 3/4" WELDON - med HM platter

Ø 17,5 - 40 mm Hulsave med skæredybde på 35 mm

HAJO varenummer: **NJET35xx**



### NITTO Centerspids for NJET

Tilhørende centerspids for NJET Ø 17,5 - 40 mm:  
Ø 8 x 91 mm HAJO varenummer: **NJET350891**



### NITTO JETBROACH hulsave lange: ONE-TOUCH / 3/4" WELDON - med HM platter

Ø 17,5 - 65 mm Hulsave med skæredybde på 50 mm

HAJO varenummer: **NJET50xx**



### NITTO Centerspids for NJET

Tilhørende centerspids for NJET Ø 17,5 - 65 mm:  
Ø 8 x 102 mm HAJO varenummer: **NJET5008102**



### NITTO QA6500 - Fulldautomatisk magnetboremaskine

#### Hvorfor vælge automatik ?

- fordi det sparer hulsave !.....

#### Hulsavene holder længere fordi:

Nitto automatiske magnetboremaskiner sørger altid for den korrekte tilspænding og det rigtige omdrejningstal.

#### Hvordan ?

Indbyggede følere måler skæremodstand, afhængig af materialehårdhed, diameter og boreddybde samt hulsavens beskaffenhed.

Kun NITTO's automatiske maskiner har disse fordele.

### Magnetisk spånopsamler:

HAJO varenummer: **A18654**



Maskine se side



### Leverandør info:

HAJO TOOL A/S  
Vejlegårdsvej 65B  
2665 Vallensbæk Strand

Telefon: 44 44 24 00  
Fax: 44 44 08 33  
Web: www.hajo.dk



# QA4000 MAGNETBOREMASKINE

## NITTO fuldautomatisk boremaskine

- med dobbelt sensor system og ONE-TOUCH lyn-bajonet system.

**FULDAUTOMATISK**



HAJO Varenummer: N1QA4000

### Data:

Max. kap. hulsav:	Ø 40 x 35 mm
Optagen effekt:	680 watt
Omdr./min ubelast.:	750*
Mål (L)x(H)x(B) mm:	407 x 425 x 215
Magnetholdekraft:	680 Kg
Magnetfod mm:	82 x 172
Lyn-bajonet system:	JA / ONE-TOUCH
Integreret smøring:	JA
Vægt:	18 Kg

- \*Fuldautomatisk maskine med dobbelt sensor system der kontrollerer tilspændings- og rotations hastighed.
- Auto-return som returnerer boret til start position.
- Fingertouch start / stop.
- Automatisk overbelastnings system
- Dobbelt rullejesty.

## NITTO HIBROACH hulsave:

NITTO ONE-TOUCH HULSAVE HIBROACH

Ø 14 - 40 mm i en skæredybde på 25 mm

HAJO varenummer: **NHHS25xx**



## NITTO JETBROACH hulsave

ONE-TOUCH / 3/4" WELDON - med HM platter

Ø 17,5 - 40 mm Hulsave med skæredybde på 35 mm

HAJO varenummer: **NJET35xx**



## NITTO Centerspids for NHHS

Tilhørende centerspids for NHHS Ø 14 - 17 mm:  
Ø 6 x 77 mm HAJO varenummer: **NHHS250677**



Tilhørende centerspids for NHHS Ø 18 - 40 mm:  
Ø 8 x 91 mm HAJO varenummer: **NHHS250891**

## NITTO Centerspids for NJET

Tilhørende centerspids for NJET Ø 17,5 - 40 x 35 mm:  
Ø 8 x 91 mm HAJO varenummer: **NJET350891**



### Leverandør info:

HAJO TOOL A/S  
Vejlegårdsvej 65B  
2665 Vallensbæk Strand

Telefon: 44 44 24 00  
Fax: 44 44 08 33  
Web: www.hajo.dk



Tilbehør se ----->

A

# QA4000 MAGNETBOREMASKINE

## TILBEHØR / INFO

### Magnetisk spånopsamler:

HAJO varenummer:

A18654



### NITTO QA4000 - Fulldautomatisk magnetboremaskine

**Hvorfor vælge automatik ?**  
- fordi det sparer hulsave !

#### Hulsavene holder længere fordi:

Nitto automatiske magnetboremaskiner sørger altid for den korrekte tilspænding og det rigtige omdrejningstal.

#### Hvordan ?

Indbyggede følere måler skæremodstand, afhængig af materialehårdhed, diameter og boreddybde samt hulsavens beskaffenhed.

**Kun NITTO´s automatiske maskiner har disse fordele.**



Maskine se side



#### Leverandør info:

HAJO TOOL A/S  
Vejlegårdsvej 65B  
2665 Vallensbæk Strand

Telefon:

44 44 24 00

Fax:

44 44 08 33

Web:

www.hajo.dk



**HAJO TOOL**  
Professionelt specialværktøj

# WA5000 MAGNETBOREMASKINE

**NITTO automatisk 2 gears boremaskine**  
- med dobbelt sensor system og ONE-TOUCH lyn-bajonet system.

**AUTOMATISK**



HAJO Varenummer: N1WA5000

## Data:

Max. kap. Hulsav.:	Ø 50 x 75 mm
Optagen effekt.:	1.100 watt
Omdr./min ubelast.:	350 / 650*
Mål (L)x(H)x(B) mm.:	425 x 613 x 237
Magnetholdekraft.:	1.000 Kg
Magnetfod mm.:	101 x 201
Lyn-bajonet system:	JA / ONE-TOUCH
Integreret smøring.:	JA
Vægt.:	23 Kg

- \*Automatisk maskine med dobbelt sensor system der kontrollerer tilspændings- og rotations hastighed.
- Fingertouch start / stop.
- Automatisk overbelastnings system
- Dobbelt rullelejestyr.

## NITTO HIBROACH Hulsave korte:

NITTO ONE-TOUCH / WELDON HULSAVE  
Ø 14 - 50 mm i en skæredybde på 25 mm

HAJO varenummer: **NHHS25xx**



## NITTO HIBROACH Hulsav lange:

NITTO ONE-TOUCH / WELDON HULSAVE  
Ø 14 - 50 mm i en skæredybde på 50 mm

HAJO varenummer: **NHHS50xx**



## NITTO Centerspids for NHHS

Tilhørende centerspids for NHHS Ø 14 - 17 mm  
Ø 6 x 77 mm HAJO varenummer: **NHHS250677**



Tilhørende centerspids for NHHS Ø 18 - 50 mm  
Ø 8 x 91 mm HAJO varenummer: **NHHS250891**

## NITTO Centerspids for NHHS

Tilhørende centerspids for NHHS Ø 14 - 18 mm  
Ø 6 x 102 mm HAJO varenummer: **NHHS5006102**



Tilhørende centerspids for NHHS Ø 19 - 50 mm  
Ø 8 x 102 mm HAJO varenummer: **NHHS5008102**

## Leverandør info:

HAJO TOOL A/S  
Vejlegårdsvej 65B  
2665 Vallensbæk Strand

Telefon: 44 44 24 00  
Fax: 44 44 08 33  
Web: www.hajo.dk



Tilbehør se side

----->

A



# WA5000 MAGNETBOREMASKINE

## TILBEHØR / INFO

### NITTO JETBROACH korte

ONE-TOUCH / 3/4" WELDON - med HM platter

Ø 17,5 - 35 mm Hulsave med skæredybde på 35 mm  
HAJO varenummer: **NJET35xx**



### NITTO centerspids

Centerspids for skæredybde 35 mm:

Ø 8 x 91 mm HAJO varenummer **NJET350891**



### NITTO JETBROACH lange:

ONE-TOUCH / 3/4" WELDON - med HM platter

Ø 17,5 - 55 mm Hulsave med skæredybde på 50 mm  
HAJO varenummer: **NJET50xx**

### NITTO JETBROACH extra lange:

ONE-TOUCH / 3/4" WELDON - med HM platter

Ø 18 - 55 mm Hulsave med skæredybde på 75 mm  
HAJO varenummer: **NJET75xx**



### NITTO Centerspids for NJET

Centerspids for skæredybde 50 mm:

Ø 8 x 102 mm HAJO varenummer: **NJET5008102**

Centerspids for skæredybde 75 mm:

Ø 8 x 133 mm HAJO varenummer: **NJET7508133**



### Magnetisk spånopsamler:

HAJO varenummer: **A18654**



## Hvorfor vælge automatik ?

### - fordi det sparer hulsave !

### Hulsavene holder længere fordi:

Nitto automatiske magnetboremaskiner sørger altid for den korrekte tilspænding og det rigtige omdrejningstal.

### Hvordan ?

Indbyggede følere måler skæremodstand, afhængig af materialehårdhed, diameter og boreddybde samt hulsavens beskaffenhed.

**Kun NITTO's automatiske maskiner har disse fordele.**

Maskine se side



### Leverandør info:

HAJO TOOL A/S  
Vejlegårdsvej 65B  
2665 Vallensbæk Strand

Telefon: 44 44 24 00  
Fax: 44 44 08 33  
Web: www.hajo.dk



**HAJO TOOL**  
Professionelt specialværktøj

# WA3500 MAGNETBOREMASKINE

**NITTO automatisk magnetboremaskine**  
- med dobbelt sensor system og ONE-TOUCH lyn-bajonet system.

**AUTOMATISK**



HAJO Varenummer: N1WA3500

## Data:

Max. kap. Hulsav:	Ø 35 x 35 mm
Optagen effekt:	1.100 watt
Omdr./min ubelast.:	950*
Mål (L)x(H)x(B) mm:	409 x 535 x 192
Magnetholdekraft:	720 Kg.
Magnetfod mm:	90 x 210
Lyn-bajonet system:	JA / ONE-TOUCH
Integreret smøring:	JA
Vægt:	19 Kg

- \*Automatisk maskine med Dobbelt sensor system der kontrollerer tilspændings- og rotations hastighed.
- Fingertouch start / stop.
- Automatisk overbelastnings system
- Dobbelt rullelejestyr.

## NITTO HIBROACH Hulsave :

NITTO ONE-TOUCH / WELDON HULSAVE  
Ø 14 - 35 mm i en skæredybde på 25 mm

HAJO varenummer: **NHHS25xx**



## NITTO JETBROACH Hulsave:

NITTO ONE-TOUCH / WELDON HULSAVE  
Ø 17,5 - 35 mm i en skæredybde på 35 mm

HAJO varenummer: **NJET35xx**



## NITTO Centerspids for NHHS

Tilhørende centerspids for NHHS Ø 14 - 17 mm:  
Ø 6 x 77 mm HAJO varenummer: **NHHS250677**



Tilhørende centerspids for NHHS Ø 18 - 35 mm:  
Ø 8 x 91 mm HAJO varenummer: **NHHS250891**

## NITTO Centerspids for NJET

Tilhørende centerspids for NJET Ø 17,5 - 35 mm:  
Ø 8 x 91 mm HAJO varenummer: **NJET350891**



## Leverandør info:

HAJO TOOL A/S  
Vejlegårdsvej 65B  
2665 Vallensbæk Strand

Telefon: 44 44 24 00  
Fax: 44 44 08 33  
Web: www.hajo.dk



Tilbehør se ----->

A

# WA3500 MAGNETBOREMASKINE TILBEHØR / INFO

## Magnetisk spånopsamler:

HAJO varenummer: A18654



## NITTO WA3500 - Automatisk magnetboremaskine

Hvorfor vælge automatik ? - fordi det sparer hulsave !

### Hulsavene holder længere fordi:

Nitto automatiske magnetboremaskiner kører automatisk den korrekte tilspænding og det rigtige omdrejningstal.

### Hvordan ?

Indbyggede følere måler skæremodstand, afhængig af materialehårdhed, diameter og boreddybde samt hulsavens beskaffenhed.

Kun NITTO's automatiske maskiner har disse fordele.

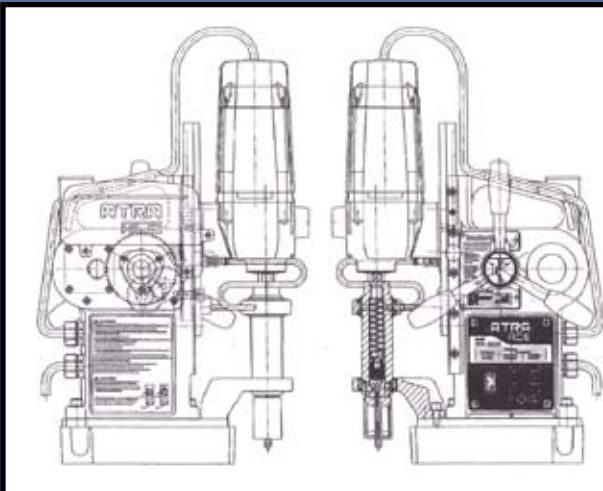

Maskine se side



## Leverandør info:

HAJO TOOL A/S  
Vejlegårdsvej 65B  
2665 Vallensbæk Strand

Telefon: 44 44 24 00  
Fax: 44 44 08 33  
Web: www.hajo.dk



# AO5575 MAGNETBOREMASKINE

**NITTO Manuel 2 gears boremaskine**  
- med Smart Stop sikring & ONE-TOUCH lyn-bajonet system.

## MANUEL



HAJO Varenummer: N1AO5575

Data:	
Kap. hulsav:	Ø 55 x 75 mm
Højdejustering:	0 - 105 mm
Optagen effekt:	1.150 watt
Omdr./min ubelast.:	350 / 650
Mål (L)x(H)x(B) mm:	280 x 506 x 150
Magnetholdekraft:	1.020 Kg
Magnetfod mm:	86 x 170
**Smart Stop / Rapid Start:	JA
Integreret smøring:	JA
Vægt:	18 Kg

(\*\*Smart Stop sikring: - Se side →)

## NITTO HIBROACH hulsave korte:

NITTO ONE-TOUCH HSS HULSAVE  
Ø 12 - 52 mm i en skæredybde på 25 mm

HAJO varenummer: **NHHS25xx**



## NITTO HIBROACH hulsave lange:

NITTO ONE-TOUCH HSS HULSAVE  
Ø 12 - 52 mm i en skæredybde på 50 mm

HAJO varenummer: **NHHS50xx**



## NITTO Centerspids for NHHS

Tilhørende centerspids for NHHS Ø 12 - 17 mm:

Ø 6 x 77 mm HAJO varenummer: **NHHS250677**



Tilhørende centerspids for NHHS Ø 18 - 52 mm:

Ø 8 x 91mm HAJO varenummer: **NHHS250891**

## NITTO Centerspids for NHHS

Tilhørende centerspids for NHHS Ø 12 - 18 mm:

Ø 6 x 102 mm HAJO varenummer: **NHHS5006102**



Tilhørende centerspids for NHHS Ø 19 - 52 mm:

Ø 8 x 102 mm HAJO varenummer: **NHHS5008102**

## Leverandør info:

HAJO TOOL A/S  
Vejlegårdsvej 65B  
2665 Vallensbæk Strand

Telefon: 44 44 24 00  
Fax: 44 44 08 33  
Web: www.hajo.dk



Tilbehør se side

----->

A



# AO5575 MAGNETBOREMASKINE

## TILBEHØR / INFO

### NITTO JETBROACH korte

ONE-TOUCH / 3/4" WELDON - med HM platter

Ø 17,5 - 35 mm Hulsave med skæredybde på 35 mm  
HAJO varenummer: **NJET35xx**



### NITTO centerspids

Centerspids for skæredybde 35 mm:  
Ø 8 x 91 mm HAJO varenummer **NJET350891**



### NITTO JETBROACH lange:

ONE-TOUCH / 3/4" WELDON - med HM platter

Ø 17,5 - 55 mm Hulsave med skæredybde på 50 mm  
HAJO varenummer: **NJET50xx**



### NITTO JETBROACH extra lange:

ONE-TOUCH / 3/4" WELDON - med HM platter

Ø 18 - 55 mm Hulsave med skæredybde på 75 mm  
HAJO varenummer: **NJET75xx**

### Magnetisk spånopsamler:

HAJO varenummer: **A18654**



### NITTO Centerspids for NJET

Centerspids for skæredybde 50 mm:  
Ø 8 x 102 mm HAJO varenummer: **NJET5008102**  
Centerspids for skæredybde 75 mm:  
Ø 8 x 133 mm HAJO varenummer: **NJET7508133**



### \*\*Smart Stop sikring:

Under boring vil indikatoren skifte farve alt efter belastning, fra grøn over Orange til Rød. Hvis der kommer for stor en belastning vil indikatoren skifte til "hurtigt blinkende rød" og motoren vil sætte borehastigheden ned og midlertidig stoppe. Hvis belastningen lettes vil motoren genstarte og der kan bores videre. Ved en forsæt hård belastning vil indikatoren gå fra "hurtigt blinkende rød" til "langsomt blinkende grøn" og motoren slår fra. Let belastningen og start igen.

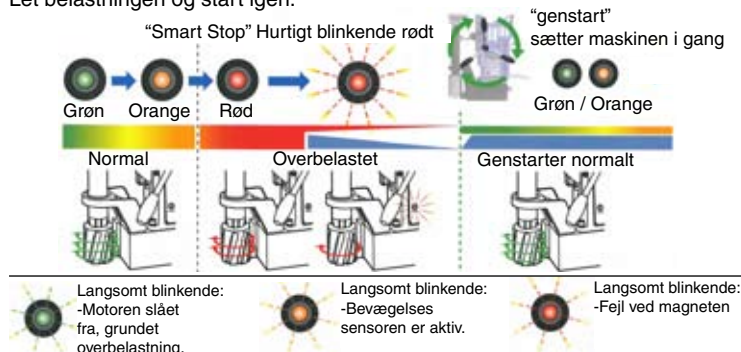

Maskine se side



### Leverandør info:

HAJO TOOL A/S  
Vejlegårdsvej 65B  
2665 Vallensbæk Strand

Telefon: 44 44 24 00  
Fax: 44 44 08 33  
Web: www.hajo.dk



# WOJ-3200 MAGNETBOREMASKINE

**NITTO Letvægts magnetboremaskine**  
- med Smart Stop sikring & ONE-TOUCH lyn-bajonet system.

## MANUEL

HAJO Varenummer: N1WOJ3200



### Data:

Kap. hulsav:	Ø 32 x 50 mm
Højdejustering:	60 mm
Optagen effekt:	950 watt
Omdr./min ubelast.:	870
Mål (L)x(H)x(B) mm:	318 x 361 x 194
Magnetholdekraft:	9000 N
Magnetfod mm:	99 x 177
**Smart Stop / Rapid Start:	JA
Integreret smøring:	NEJ/ ekstra tilbehør
Vægt:	13 Kg

### NITTO JETBROACH korte hulsave

med HM platter skæredybde 35 mm  
med ONE-TOUCH lynbajonet + 3/4" WELDON skaft  
Ø 17,5 – 32mm HAJO varenummer **NJET35xx**



NITTO centerspids for 35 mm skæredybde  
Ø 8 x 91 mm HAJO varenummer **NJET350891**



### NITTO JETBROACH lange hulsave

med HM platter skæredybde 50 mm  
med ONE-TOUCH lynbajonet + 3/4" WELDON skaft  
Ø 17,5 – 32 mm HAJO varenummer **NJET50xx**



NITTO centerspids for 50 mm skæredybde  
Ø 8 x 102 mm HAJO varenummer **NJET5008102**



### Leverandør info:

HAJO TOOL A/S  
Vejlegårdsvej 65B  
2665 Vallensbæk Strand

Telefon: 44 44 24 00  
Fax: 44 44 08 33  
Web: www.hajo.dk



Tilbehør se side

----->

A

# WOJ 3200 MAGNETBOREMASKINE

## TILBEHØR / INFO



Kan betjenes  
fra begge  
sider.

Lyn højde  
indstilling



**NITTO 13 mm borepatron**  
HAJO varenummer **N1TB07690**



**NITTO SPÅNBRYDER**  
HAJO varenummer **N1TQ11523**

**Oliebeholder med beslag**  
HAJO varenummer **N1TB07695**

**Smørekande**  
HAJO varenummer **N1TQ10581**

### \*\*Smart Stop sikring:

Under boring vil indikatoren skifte farve alt efter belastning, fra grøn over Orange til Rød. Hvis der kommer for stor en belastning vil indikatoren skifte til "hurtigt blinkende rød" og motoren vil sætte borehastigheden ned og midlertidig stoppe. Hvis belastningen lettes vil motoren genstarte og der kan bores videre. Ved en forsat hård belastning vil indikatoren gå fra "hurtigt blinkende rød" til "langsomt blinkende grøn" og motoren slår fra. Let belastningen og start igen.

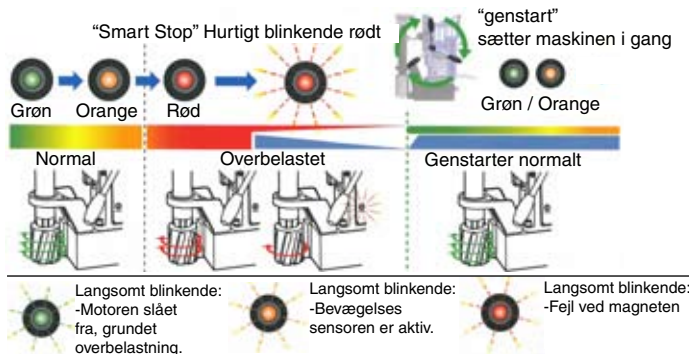

### Magnetisk spånopsamler:

HAJO varenummer: **A18654**



Maskine se side



### Leverandør info:

HAJO TOOL A/S  
Vejlegårdsvej 65B  
2665 Vallensbæk Strand

Telefon: 44 44 24 00  
Fax: 44 44 08 33  
Web: www.hajo.dk



# HA3200 MAGNETBOREMASKINE

## Allround letvægts boremaskine

- med højdejustering og mulighed for boring med spiralbor

# Manuel



HAJO Varenummer: N1HA3200

### Data:

Kap. hulsav:	Ø 32 x 50 mm
*Kap. spiralbor:	13 mm
Slædevandring:	129 mm
Højdejustering:	0 - 205 mm
Optagen effekt:	1050 watt
Omdr./min ubelast.:	400
Mål (L)x(H)x(B) mm:	280 x 390 x 150
Magnetholdekraft:	800 Kg
Magnetfod mm:	70 x 160
Integreret smøring:	JA
Vægt:	10 Kg

\* = Se borepatron med adapter

### Hulsave korte:

HAJO HULSAVE SHHS KORTE  
Ø 12 - 32 mm i en skæredybde på 25 mm

HAJO varenummer: **SHHS25xx**



### Hulsave lange:

HAJO HULSAVE SHHS LANGE  
Ø 14 - 32 mm i en skæredybde på 50 mm

HAJO varenummer: **SHHS50xx**



### Centerspids kort

Tilhørende centerspids for korte hulsave:

Ø 6 x 77 mm      varenummer: **SHHS250677**



### Centerspids lang

Tilhørende centerspids for lange hulsave:

Ø 6 x 102 mm      varenummer: **SHHS5006102**



### Leverandør info:

HAJO TOOL A/S  
Vejlegårdsvej 65B  
2665 Vallensbæk Strand

Telefon: 44 44 24 00  
Fax: 44 44 08 33  
Web: www.hajo.dk



Tilbehør se side

----->

A



# HA3200 MAGNETBOREMASKINE TILBEHØR

## \*Borepatron med adapter:

Selvspændende borepatron 13 mm  
med 19 mm WELDON Adapter

HAJO varenummer: **A18107H**



## Weldon forlænger:

3/4" WELDON Forlænger Ø 32 x 81 mm

HAJO varenummer: **A20206**



## Hulsavssæt:

HAJO HULSAVSSÆT KORTE  
10 Stk. hulsave fra Ø12 - 30 mm, 25 mm skæredybde  
2 Stk. Centerspidser Ø 6 X 77 mm

HAJO varenummer: **SHHS25SET**

HAJO HULSAVSSÆT LANGE  
9 Stk. hulsave fra Ø14 - 30 mm, 50 mm skæredybde  
1 Stk. Centerspids Ø 6 X 102 mm

HAJO varenummer: **SHHS50SAET**



## Magnetisk spånopsamler:

HAJO varenummer: **A18654**



## HSS undersænker:

HSS Undersænker / afgrater i tre størrelser

Ø 25 mm 90° HAJO varenummer: **A18533**

Ø 30 mm 90° HAJO varenummer: **A18536**

Ø 40 mm 90° HAJO varenummer: **A18534**

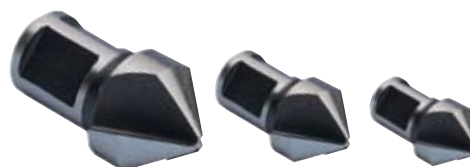

Maskine se side



## Leverandør info:

HAJO TOOL A/S  
Vejlegårdsvej 65B  
2665 Vallensbæk Strand

Telefon: 44 44 24 00  
Fax: 44 44 08 33  
Web: www.hajo.dk



# AV32 MAGNETBOREMASKINE

ALFRA vinkel-magnetboremaskine med Weldon.  
- Lav Højde (helt ned til 228 mm) og integreret smøring.

Vinkel

HAJO Varenummer: AV32

## Data:

Kap. hulsav:	Ø 32 x 25 mm
Kap. forsækning:	10 - 30 mm
Slædevandring:	45 mm
Optagen effekt.:	900 watt.
Omdr./min ubelast.:	450
Mål (L)x(H)x(B) mm:	361 x 228 x 127
Magnetholdekraft:	1.600 Kg
Magnetfod mm:	95 x 200
Lyn-bajonet system:	NEJ
Integreret smøring:	JA
Vægt:	12,5 Kg

- inkl. smøre-enhed med slange og nippel,  
sekskantnøgle, transportkasse,  
hulsav Ø 18x25 mm og centerspids for AV32.



## Hulsave korte:

HAJO HULSAVE SHHS KORTE  
Ø 12 - 32 mm i en skæredybde på 25 mm

HAJO varenummer: SHHS25xx



## Hulsavssæt:

HAJO HULSAVSSÆT KORTE  
10 Stk. hulsave fra Ø12 - 30 mm, 25 mm skæredybde  
2 Stk. Centerspidser Ø 6 X 77 mm

HAJO varenummer: SHHS25SET



## Centerspids kort

Tilhørende centerspids for korte hulsave:  
Ø 6 x 77 mm HAJO varenummer: SHHS250677



## Leverandør info:

HAJO TOOL A/S  
Vejlegårdsvej 65B  
2665 Vallensbæk Strand

Telefon: 44 44 24 00  
Fax: 44 44 08 33  
Web: www.hajo.dk



Tilbehør se side

----->

A

# AV32 MAGNETBOREMASKINE

## TILBEHØR / MÅL SKITSE

### Magnetisk spånopsamler:

HAJO varenummer:

**A18654**



### HSS undersænkere:

HSS Undersænker / afgrater i to størrelser

Ø 25 mm 90° HAJO varenummer: **A18533**

Ø 30 mm 90° HAJO varenummer: **A18536**

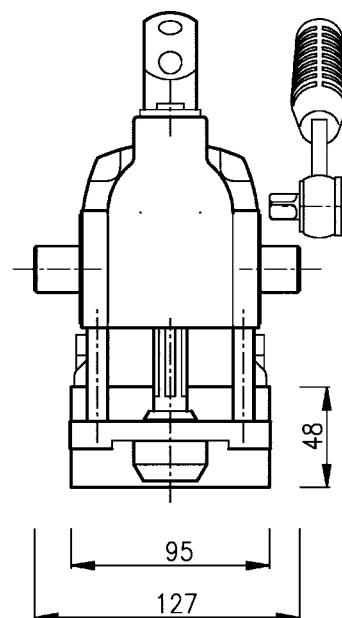
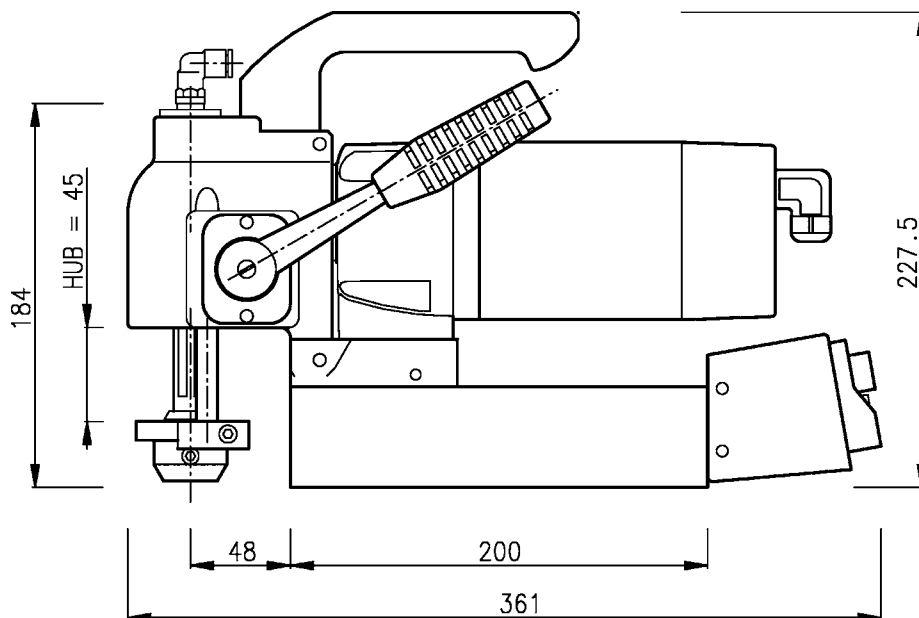
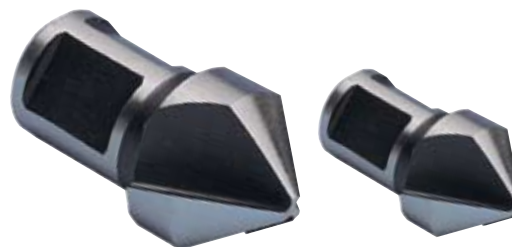

Maskine se side



### Leverandør info:

HAJO TOOL A/S  
Vejlegårdsvej 65B  
2665 Vallensbæk Strand

Telefon:

44 44 24 00

Fax:

44 44 08 33

Web:

www.hajo.dk



**HAJO TOOL**

Professionelt specialværktøj

# A32/50RQ MAGNETBOREMASKINE

Letvægts ALFRA boremaskine med lynbajonet  
- Højdejustering og mulighed for boring med spiralbor.

## Manuel

HAJO Varenummer: A32/50RQ



### Data:

Kap. hulsav:	Ø 32 x 50 mm
*Kap. spiralbor:	13 mm
Slædevandring:	129 mm
Højdejustering:	0 - 205 mm
Optagen effekt:	1050 watt
Omdr./min ubelast.:	400
Mål (L)x(H)x(B) mm:	280 x 390 x 150
Magnetholdekraft:	800 Kg
Magnetfod mm:	70 x 160
Lyn-bajonet system:	JA
Integreret smøring:	JA
Vægt:	10 Kg

\* = Se borepatron med adapter på side 2

### Hulsave korte:

HAJO HULSAVE SHHS KORTE  
Ø 12 - 32 mm i en skæredybde på 25 mm

HAJO varenummer: **SHHS25xx**



### Hulsave lange:

HAJO HULSAVE SHHS LANGE  
Ø 14 - 32 mm i en skæredybde på 50 mm

HAJO varenummer: **SHHS50xx**



### Centerspids kort

Tilhørende centerspids for korte hulsave:

Ø 6 x 77 mm      varenummer: **SHHS250677**



### Centerspids lang

Tilhørende centerspids for lange hulsave:

Ø 6 x 102 mm      varenummer: **SHHS5006102**



### Leverandør info:

HAJO TOOL A/S  
Vejlegårdsvej 65B  
2665 Vallensbæk Strand

Telefon: 44 44 24 00  
Fax: 44 44 08 33  
Web: www.hajo.dk



Tilbehør se side

----->

A



# A32/50RQ MAGNETBOREMASKINE TILBEHØR

## \*Borepatron med adapter:

Selvspændende borepatron 13 mm  
med 19 mm ROTAQUICK Adapter

HAJO varenummer: **A18107**



## Weldon forlænger:

3/4" WELDON forlænger Ø 32 x 81 mm

HAJO varenummer: **A20206**



## Hulsavssæt:

HAJO HULSAVSSÆT KORTE  
10 Stk. hulsave fra Ø12 - 30 mm, 25 mm skæredybde  
2 Stk. Centerspidser Ø 6 X 77 mm

HAJO varenummer: **SHHS30SET**

HAJO HULSAVSSÆT LANGE  
9 Stk. hulsave fra Ø14 - 30 mm, 50 mm skæredybde  
1 Stk. Centerspids Ø 6 X 102 mm

HAJO varenummer: **SHHS50SAET**



## Magnetisk spånopsamler:

HAJO varenummer: **A18654**



## HSS undersænkere:

HSS Undersænker / afgrater i tre størrelser

Ø 25 mm 90° HAJO varenummer: **A18533**

Ø 30 mm 90° HAJO varenummer: **A18536**

Ø 40 mm 90° HAJO varenummer: **A18534**

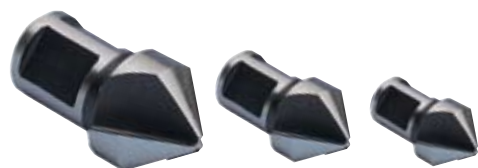

Maskine se side



## Leverandør info:

HAJO TOOL A/S  
Vejlegårdsvej 65B  
2665 Vallensbæk Strand

Telefon: 44 44 24 00  
Fax: 44 44 08 33  
Web: www.hajo.dk



# A40RQ MAGNETBOREMASKINE

**ALFRA 2 gears boremaskine med lynbajonet**  
- Højdejusterbar, spiralboring og mulighed for gevindskæring\*.

## Manuel

HAJO Varenummer:

A40RQ

### Data:

Max. kap. Hulsav.:	Ø 40 x 50 mm
Max. kap. Spiralbor.:	13 mm
Gevindskæring (se tilbehør):	M3 - M12*
Slædevandring:	170 mm
Højdejustering:	0 - 100 mm
Optagen effekt.:	1.200 watt.
Omdr./min ubelast.:	250 / 450
Mål (L)x(H)x(B) mm.:	335 x 529 x 192
Magnetholdekraft.:	1.600 Kg.
Magnetfod mm.:	80 x 230
Lyn-bajonet system:	JA
Integreret smøring.:	JA
Vægt.:	16 Kg.

- Ergonomisk placeret kontaktpanel.  
- inkl. 13 mm selvsp. borepatron, spånfjerner,  
22 mm hulsav, 6 mm centerpind og bore/køle spray.



### Hulsave korte:

HAJO HULSAVE SHHS KORTE  
Ø 12 - 40 mm i en skæredybde på 25 mm

HAJO varenummer: **SHHS25xx**



### Hulsave lange:

HAJO HULSAVE SHHS LANGE  
Ø 14 - 40 mm i en skæredybde på 50 mm

HAJO varenummer: **SHHS50xx**



### Centerspids kort

Tilhørende centerspids for korte hulsave:  
Ø 6 x 77 mm HAJO varenummer: **SHHS250677**



### Centerspids lang

Tilhørende centerspids for lange hulsave:  
Ø 6 x 102 mm HAJO varenummer: **SHHS5006102**



### Leverandør info:

HAJO TOOL A/S  
Vejlegårdsvej 65B  
2665 Vallensbæk Strand

Telefon: 44 44 24 00  
Fax: 44 44 08 33  
Web: www.hajo.dk



Tilbehør se side

----->

A

# A40RQ MAGNETBOREMASKINE TILBEHØR

## Hulsavssæt:

### HAJO HULSAVSSÆT KORTE

10 Stk. hulsave fra Ø12 - 30 mm, 25 mm skæredybde  
2 Stk. Centerspidser Ø 6 X 77 mm

HAJO varenummer: **SHHS25SET**

### HAJO HULSAVSSÆT LANGE

9 Stk. hulsave fra Ø14 - 30 mm, 50 mm skæredybde  
1 Stk. Centerspidser Ø 6 X 102 mm

HAJO varenummer: **SHHS50SÆT**



## HSS undersænker:

HSS Undersænker / afgrater i tre størrelser

Ø 25 mm 90° HAJO varenummer: **A18533**

Ø 30 mm 90° HAJO varenummer: **A18536**

Ø 40 mm 90° HAJO varenummer: **A18534**



## Borepatron med adapter:

Selvspændende borepatron 13 mm  
med 19 mm ROTAQUICK Adapter

HAJO varenummer: **A18107**

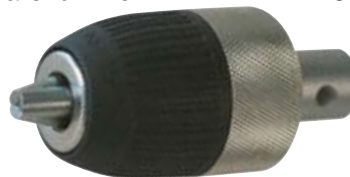

## Weldon forlænger:

3/4" WELDON forlænger Ø 32 x 81 mm

HAJO varenummer: **A20206**



## Magnetisk spånopsamler:

HAJO varenummer: **A18654**



## \*Gevindskæringsapparat:

Anvendes til gevindskæring, samt returgang, på  
maskiner med højreløb. (M3 - M12)

HAJO varenummer: **A18652**

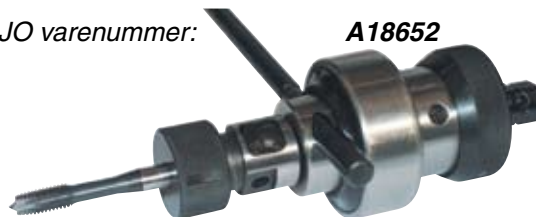

Maskine se side



## Leverandør info:

HAJO TOOL A/S  
Vejlegårdsvej 65B  
2665 Vallensbæk Strand

Telefon: 44 44 24 00  
Fax: 44 44 08 33  
Web: www.hajo.dk



# A40RL-E MAGNETBOREMASKINE

**ALFRA 2 gears boremaskine højre- / venstreløb, MK2**  
- Højdejusterbar, spiralboring og mulighed for gevindskæring.\*

## Manuel

**Bemærk!**  
Hulsave kan kun benyttes med ekstra tilbehør...  
A18003 MK2  
eller  
A18650 MK2



HAJO Varenummer: **A40RLE**

### Data:

Max. kap. hulsav: **	(Ø 40 x 50 mm)
Max. kap. spiralbor:	16 mm
Gevindskæring (se tilbehør):	M3 - M14***
Højre / venstreløb:	JA
Slædevandring:	170 mm
Højdejustering:	0 - 100 mm
Optagen effekt:	1.200 watt
Omdr./min ubelast.:	100-250 / 180-450
Mål (L)x(H)x(B) mm:	335 x 529 x 192
Magnetholdekraft:	1.600 Kg
Magnetfod mm:	80 x 230
Integreret smøring:	JA
Vægt:	16 Kg

- Ergonomisk placeret kontaktpanel
- Elektronisk varme- og overbelastningssikring,
- 16 mm borepatron MK2, spånfjerner, bore/køle spray.

## Bemærk! \*\*

Hulsave kan kun benyttes med ekstra tilbehør: A18003 MK2 holder eller A18650 MK2 Rota quick.

### Hulsave korte:

HAJO HULSAVE SHHS KORTE  
Ø 12 - 40 mm i en skæredybde på 25 mm

HAJO varenummer: **SHHS25xx**



### Centerspids kort

Tilhørende centerspids for korte hulsave:  
Ø 6 x 77 mm HAJO varenummer: **SHHS250677**



### Hulsave lange:

HAJO HULSAVE SHHS LANGE  
Ø 14 - 40 mm i en skæredybde på 50 mm

HAJO varenummer: **SHHS50xx**



### Centerspids lang

Tilhørende centerspids for lange hulsave:  
Ø 6 x 102 mm HAJO varenummer: **SHHS5006102**



### Leverandør info:

HAJO TOOL A/S  
Vejlegårdsvej 65B  
2665 Vallensbæk Strand

Telefon: 44 44 24 00  
Fax: 44 44 08 33  
Web: www.hajo.dk



Tilbehør se side

----->

A



# A40RL-E MAGNETBOREMASKINE TILBEHØR

## Holdere for hulsave:

MK3 holder for hulsave Ø12 – Ø60 mm



MK2 Weldon holder, hulsaven skrues fast.  
HAJO varennummer: **A18003**



MK2 Rota Quick lynkobling.  
HAJO varennummer: **A18650**

## Magnetisk spånopsamler:

HAJO varennummer: **A18654**

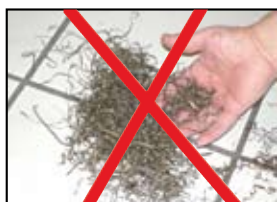

## Hulsavssæt:

HAJO HULSAVSSÆT KORTE  
10 Stk. hulsave fra Ø12 - 30 mm, 25 mm skæredybde  
2 Stk. Centerspidser Ø 6 X 77 mm

HAJO varennummer: **SHHS25SET**

HAJO HULSAVSSÆT LANGE

9 Stk. hulsave fra Ø14 - 30 mm, 50 mm skæredybde  
1 Stk. Centerspids Ø 6 X 102 mm

HAJO varennummer: **SHHS50SÆT**



## HSS undersænkere:

HSS Undersænker / afgrater i fire størrelser

Ø 25 mm 90° HAJO varennummer: **A18533**

Ø 30 mm 90° HAJO varennummer: **A18536**

Ø 40 mm 90° HAJO varennummer: **A18534**



## Weldon forlænger:

3/4" WELDON forlænger Ø 32 x 81 mm

HAJO varennummer: **A20206**



## \*\*\*Tapholdersæt for snittappe:

M3 - M14 Inkl. MK2 adapter i trækasse.

HAJO varennummer: **A18660**



Maskine se side



## Leverandør info:

HAJO TOOL A/S  
Vejlegårdsvej 65B  
2665 Vallensbæk Strand

Telefon: 44 44 24 00  
Fax: 44 44 08 33  
Web: www.hajo.dk



# A60-2 MAGNETBOREMASKINE

ALFRA 2 gears boremaskine med 19mm Weldon  
- Højdejusterbar med mulighed for spiralboring\* & gevindskæring.

## Manuel

HAJO Varenummer:

A60-2

### Data:

Max. kap. hulsav: Ø 60 x 50 mm  
Max. kap. spiralbor Ø: 13\* mm  
Gevindskæring: M3 - M12\*\*  
Slædevandring: 190 mm  
Højdejustering: 0 - 60 mm  
Optagen effekt: 1.800 watt  
Omdr./min ubelast.: 230 / 450  
Mål (L)x(H)x(B) mm: 358 x 597 x 210  
Magnetholdekraft: 2.000 Kg  
Magnetfod mm: 80 x 230  
Drejebar magnet: 30 gr  
Integreret smøring: JA  
Vægt: 16 Kg

- Ergonomisk placeret kontaktpanel
- Elektronisk varme- og overbelastningssikring,
- spånfjerner, bore/køle spray, sikkerhedskæde og transport kasse .

(\* med ekstra tilbehør borepatron A18107H) (\*\*se) →



### Hulsave korte:

HAJO HULSAVE SHHS KORTE  
Ø 12 - 60 mm i en skæredybde på 25 mm

HAJO varenummer: **SHHS25xx**



### Hulsave lange:

HAJO HULSAVE SHHS LANGE  
Ø 14 - 60 mm i en skæredybde på 50 mm

HAJO varenummer: **SHHS50xx**



### Centerspids kort

Tilhørende centerspids for korte hulsave:  
Ø 6 x 77 mm HAJO varenummer: **SHHS250677**



### Centerspids lang

Tilhørende centerspids for lange hulsave:  
Ø 6 x 102 mm HAJO varenummer: **SHHS5006102**



### Leverandør info:

HAJO TOOL A/S  
Vejlegårdsvej 65B  
2665 Vallensbæk Strand

Telefon: 44 44 24 00  
Fax: 44 44 08 33  
Web: www.hajo.dk



Tilbehør se side

----->

A

# A60-2 MAGNETBOREMASKINE TILBEHØR

## Hulsavssæt:

HAJO HULSAVSSÆT KORTE  
10 Stk. hulsave fra Ø12 - 30 mm, 25 mm skæredybde  
2 Stk. Centerspidser Ø 6 X 77 mm

HAJO varenummer: **SHHS25SET**

HAJO HULSAVSSÆT LANGE  
9 Stk. hulsave fra Ø14 - 30 mm, 50 mm skæredybde  
1 Stk. Centerspids Ø 6 X 102 mm

HAJO varenummer: **SHHS50SAET**



## HSS undersænker:

HSS Undersænker / afgrater i fire størrelser

Ø 25 mm 90° HAJO varenummer: **A18533**

Ø 30 mm 90° HAJO varenummer: **A18536**

Ø 40 mm 90° HAJO varenummer: **A18534**

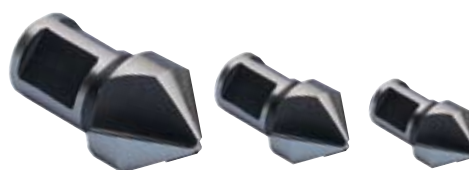

## Weldon forlænger:

3/4" WELDON forlænger Ø 32 x 81 mm

HAJO varenummer: **A20206**



## \*Borepatron med adapter:

Selvspændende borepatron 13 mm  
med 19 mm Weldon Adapter

HAJO varenummer: **A18107H**



## Magnetisk spånopsamler:

HAJO varenummer: **A18654**

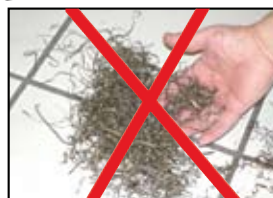

## \*\*Gevindskæreapparat:

Anvendes til gevindskæring, samt returgang, på  
maskiner med højreløb. (M3 - M12)

HAJO varenummer: **A18652**



Maskine se side



## Leverandør info:

HAJO TOOL A/S  
Vejlegårdsvej 65B  
2665 Vallensbæk Strand

Telefon: 44 44 24 00  
Fax: 44 44 08 33  
Web: www.hajo.dk



# A60RL-E MAGNETBOREMASKINE

**ALFRA 4 gears boremaskine højre+venstreløb & MK3**  
- Højdejusterbar, spiralboring og mulighed for gevindskæring.\*

## Manuel

**Bemærk!**  
Hulsave kan kun benyttes med ekstra tilbehør...  
A18025 MK3  
eller  
A18651 MK3

Ekstra  
Tilbehør  
varenr.: A18680

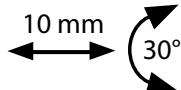

HAJO Varenummer:

A60RLE

### Data:

Incl. 16 mm borepatron MK3, spånfjerner, bore/køle spray.  
**(Max. kap.\* hulsav: Ø 60 x 50\* mm)**  
Max. kap. spiralbor Ø: 16 / 32\*\* mm  
Gevindskæring (se tilbehør): M3 - M22\*\*\*  
Højre / venstreløb: JA  
Slædevandring: 190 mm  
Højdejustering: 0 - 60 mm  
Optagen effekt: 1.800 watt  
Omdr./min ubelast.: 50-110/75-175  
- 105-245/165-385  
Mål (L)x(H)x(B) mm: 335 x 529 x 192  
Magnetoholdkraft: 2.000 Kg  
Magnetfod mm: 80 x 230  
Drejebar magnet: 30 gr  
Integreret smøring: JA  
Vægt: 16 Kg  
- Ergonomisk placeret kontaktpanel  
- Elektronisk varme- og overbelastningssikring.

### Hulsave korte:

HAJO HULSAVE SHHS KORTE  
Ø 12 - 60 mm i en skæredybde på 25 mm

HAJO varenummer: **SHHS25xx**



### Hulsave lange:

HAJO HULSAVE SHHS LANGE  
Ø 14 - 60 mm i en skæredybde på 50 mm

HAJO varenummer: **SHHS50xx**



### Centerspids kort

Tilhørende centerspids for korte hulsave:  
Ø 6 x 77 mm HAJO varenummer: **SHHS250677**



### Centerspids lang

Tilhørende centerspids for lange hulsave:  
Ø 6 x 102 mm HAJO varenummer: **SHHS5006102**



### Leverandør info:

HAJO TOOL A/S  
Vejlegårdsvej 65B  
2665 Vallensbæk Strand

Telefon: 44 44 24 00  
Fax: 44 44 08 33  
Web: www.hajo.dk



Tilbehør se side

----->

A



# A60RL-E MAGNETBOREMASKINE TILBEHØR

## Holdere for hulsave:

MK3 holder for hulsave Ø12 – Ø60 mm



MK3 Weldon holder, hulsaven skrues fast.  
HAJO varenummer: **A18025**



MK3 Rota Quick lynkobling.  
HAJO varenummer: **A18651**

## Magnetisk spånopsamler:

HAJO varenummer: **A18654**

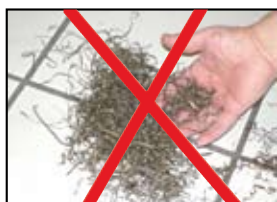

## Hulsavssæt:

HAJO HULSAVSSÆT KORTE

10 Stk. hulsave fra Ø12 - 30 mm, 25 mm skæredybde  
2 Stk. Centerspidser Ø 6 X 77 mm

HAJO varenummer: **SHHS25SET**

HAJO HULSAVSSÆT LANGE

9 Stk. hulsave fra Ø14 - 30 mm, 50 mm skæredybde  
1 Stk. Centerspids Ø 6 X 102 mm

HAJO varenummer: **SHHS50SÆT**



## HSS undersænkere:

HSS Undersænker / afgrater i fire størrelser

Ø 25 mm 90° HAJO varenummer: **A18533**

Ø 30 mm 90° HAJO varenummer: **A18536**

Ø 40 mm 90° HAJO varenummer: **A18534**



## Weldon forlænger:

3/4" WELDON forlænger Ø 32 x 81 mm

HAJO varenummer: **A20206**



## \*\*\*Tapholdersæt for snittappe:

M3 - M14 Inkl. MK2 adapter i trækasse.

HAJO varenummer: **A18660**

M6 - M22 Inkl. MK3 adapter i trækasse.

HAJO varenummer: **A18680**



Maskine se side



## Leverandør info:

HAJO TOOL A/S  
Vejlegårdsvej 65B  
2665 Vallensbæk Strand

Telefon: 44 44 24 00  
Fax: 44 44 08 33  
Web: www.hajo.dk



# A100 MAGNETBOREMASKINE

**ALFRA 4 gears MK3 boremaskine med stor kapacitet**  
- Højdejusterbar, spiralboring og mulighed for gevindskæring\*\*\*.

## Manuel

**Bemærk!**  
Hulsave kan kun benyttes med ekstra tilbehør...  
A18025 MK3 eller A18651 MK3



HAJO Varenummer:

A100

### Data:

inkl. Spånfjerner, bore/kølespray, sikkerhedsbælte, borepatron 16 mm og transportkasse

Max. kap. hulsav:	Ø 100 x 50 mm*
Max. kap. spiralbor Ø:	16 / 32** mm
Gevindskæring (se tilbehør):	M3 - M20***
Slædevandring:	245 mm
Højdejustering:	0 - 116 mm
Optagen effekt:	1.800 watt
Omdr./min ubelast.:	110 / 175 / 245 / 385
Mål (L)x(H)x(B) mm:	428 x 685 x 210
Magnetholdekraft:	2.000 Kg
Magnetfod mm:	80 x 230
Drejebar magnet:	30 gr
Integreret smøring:	JA
Vægt:	28 Kg

(\*Hulsave Ø 12 - 60 mm med adapter vnr.: A18025)  
(\*Hulsave Ø 51 - 100 mm med adapter vnr.: A20230)  
(\*\*32mm med morsekonus bor)  
(\*\*\*med gevindskæringsapparat →)

### Hulsave korte:

HAJO HULSAVE SHHS KORTE  
Ø 12 - 60 mm i en skæredybde på 25 mm

HAJO varenummer: **SHHS25xx**



### Hulsave lange:

HAJO HULSAVE SHHS LANGE  
Ø 14 - 60 mm i en skæredybde på 50 mm

HAJO varenummer: **SHHS50xx**



### Centerspids kort

Tilhørende centerspids for korte hulsave:  
Ø 6 x 77 mm

HAJO varenummer: **SHHS250677**



### Centerspids lang

Tilhørende centerspids for lange hulsave:  
Ø 6 x 102 mm

HAJO varenummer: **SHHS5006102**



### Leverandør info:

HAJO TOOL A/S  
Vejlegårdsvej 65B  
2665 Vallensbæk Strand

Telefon: 44 44 24 00  
Fax: 44 44 08 33  
Web: www.hajo.dk



Tilbehør se side

----->

A

# A100 MAGNETBOREMASKINE TILBEHØR

## Holder for hulsave:

MK3 holder for hulsave Ø12 – Ø60 mm  
MK3 holder for hulsave Ø55 – Ø100 mm

MK3 Weldon holder, hulsaven skrues fast.  
HAJO varenummer: **A18025**



MK3 holder Rota Quick lynkobling.  
HAJO varenummer: **A18651**



MK3 holder m/længdenot for hulsave  
Ø 55 – Ø100 mm i serie 2002xxx050.  
HAJO varenummer: **A20230**

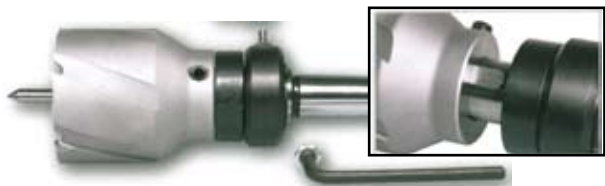

## Hulsavssæt:

HAJO HULSAVSSÆT KORTE  
10 Stk. hulsave fra Ø12 - 30 mm, 25 mm skæredybde  
2 Stk. Centerspidser Ø 6 X 77 mm

HAJO varenummer: **SHHS25SET**

HAJO HULSAVSSÆT LANGE  
9 Stk. hulsave fra Ø14 - 30 mm, 50 mm skæredybde  
1 Stk. Centerspids Ø 6 X 102 mm

HAJO varenummer: **SHHS50SÆT**



## HSS undersænker:

HSS Undersænker / afgrater i fire størrelser

Ø 25 mm 90° HAJO varenummer: **A18533**

Ø 30 mm 90° HAJO varenummer: **A18536**

Ø 40 mm 90° HAJO varenummer: **A18534**

Ø 55 mm 90° HAJO varenummer: **A18537**



## Weldon forlænger:

3/4" WELDON forlænger Ø 32 x 81 mm

HAJO varenummer: **A20206**



## Magnetisk spånopsamler:

HAJO varenummer: **A18654**

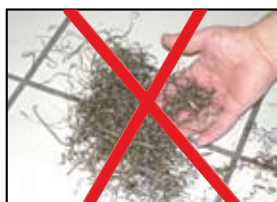

## \*\*\*Tapholdersæt for snittappe:

M3 - M14 Inkl. MK2 adapter i trækasse.

HAJO varenummer: **A18660**

M6 - M22 Inkl. MK3 adapter i trækasse.

HAJO varenummer: **A18680**



Maskine se side



## Leverandør info:

HAJO TOOL A/S  
Vejlegårdsvej 65B  
2665 Vallensbæk Strand

Telefon: 44 44 24 00  
Fax: 44 44 08 33  
Web: www.hajo.dk



# A100RLE MAGNETBOREMASKINE

ALFRA 4 gears MK3 boremaskine med stor kapacitet  
- Højdejusterbar, spiralboring og mulighed for gevindskæring\*\*\*.

## Manuel

Bemærk!  
Hulsave kan kun  
benyttes med  
ekstra tilbehør...  
A18025 MK3  
eller  
A18651 MK3



HAJO Varenummer:

A100 RLE

### Data:

Max. kap. hulsav:*	Ø 100 x 50 mm
Max. kap. spiralbor Ø:	16 / 32** mm
Gevindskæring(se tilbehør):	M3 - M22***
Slædevandring:	245 mm
Højdejustering:	0 - 116 mm
Optagen effekt:	1.800 watt
Omdr./min ubelast.:	110 / 175 / 245 / 385
Mål (L)x(H)x(B) mm:	428 x 685 x 210
Magnetholdekraft:	2.000 Kg
Magnetfod mm:	80 x 230
Drejebar magnet:	30 gr
Integreret smøring:	JA
Vægt:	28 Kg

(\*Hulsave Ø 12 - 60 mm med adapter vnr.: A18025)

(\*Hulsave Ø 51 - 100 mm med adapter vnr.: A20230)

(\*\*32mm med morsekonus bor)

(\*\*\*med gevindskæringsapparat se side )→

inkl. Spånfjerner, bore/kølespray, sikkerhedsrem og transportkasse.

### Hulsave korte:

HAJO HULSAVE SHHS KORTE  
Ø 12 - 60 mm i en skæredybde på 25 mm

HAJO varenummer:

**SHHS25xx**



### Hulsave lange:

HAJO HULSAVE SHHS LANGE  
Ø 14 - 60 mm i en skæredybde på 50 mm

HAJO varenummer:

**SHHS50xx**



### Centerspids kort

Tilhørende centerspids for korte hulsave:  
Ø 6 x 77 mm HAJO varenummer: **SHHS250677**



### Centerspids lang

Tilhørende centerspids for lange hulsave:  
Ø 6 x 102 mm HAJO varenummer: **SHHS5006102**



### Leverandør info:

HAJO TOOL A/S  
Vejlegårdsvej 65B  
2665 Vallensbæk Strand

Telefon: 44 44 24 00  
Fax: 44 44 08 33  
Web: www.hajo.dk



Tilbehør se side

----->

A



# A100 RLE MAGNETBOREMASKINE TILBEHØR

## Holder for hulsave:

MK3 holder for hulsave Ø12 – Ø60 mm

MK3 Weldon holder, hulsaven skrues fast.

HAJO varenummer: **A18025**



MK3 holder Rota Quick lynkobling.

HAJO varenummer: **A18651**



MK3 holder m/længdenot for hulsave  
Ø 55 – Ø100 mm i serie 2002xxx050.

HAJO varenummer: **A20230**



## Magnetisk spånopsamler:

HAJO varenummer: **A18654**



## Hulsavssæt:

HAJO HULSAVSSÆT KORTE

10 Stk. hulsave fra Ø12 - 30 mm, 25 mm skæredybde  
2 Stk. Centerspidser Ø 6 X 77 mm

HAJO varenummer: **SHHS25SET**

HAJO HULSAVSSÆT LANGE

9 Stk. hulsave fra Ø14 - 30 mm, 50 mm skæredybde  
1 Stk. Centerspids Ø 6 X 102 mm

HAJO varenummer: **SHHS50SÆT**



## HSS undersænker:

HSS Undersænker / afgrater i fire størrelser

Ø 25 mm 90° HAJO varenummer: **A18533**

Ø 30 mm 90° HAJO varenummer: **A18536**

Ø 40 mm 90° HAJO varenummer: **A18534**

Ø 55 mm 90° HAJO varenummer: **A18537**



## Weldon forlænger:

3/4" WELDON forlænger Ø 32 x 81 mm

HAJO varenummer: **A20206**



## \*\*\*Tapholdersæt for snittappe:

M3 - M14 Inkl. MK2 adapter i trækasse.

HAJO varenummer: **A18660**

M6 - M22 Inkl. MK3 adapter i trækasse.

HAJO varenummer: **A18680**



Maskine se side



## Leverandør info:

HAJO TOOL A/S  
Vejlegårdsvej 65B  
2665 Vallensbæk Strand

Telefon: 44 44 24 00  
Fax: 44 44 08 33  
Web: www.hajo.dk



# M100/M320 ATRA MASTER

## ATRA M100 MAGNETSTANDER

## Manuel



HAJO Varenummer: N1100

### Data:

Kap. spiralbor: 10 mm  
Slædevandring: 100 mm  
Mål (L)x(H)x(B) mm: 240 x 293 x 140  
Magnetholdekraft: 350 Kg  
Magnetfod mm.: Ø 105 mm  
Vægt: 9,0 Kg  
Adapter beslag for din maskine kan leveres.  
Kan leveres med monteret 2 gears 650 Watt  
DUSS boremaskine.  
Nr. B13/2RLE

## ATRA M320 MAGNETSTANDER

## Manuel

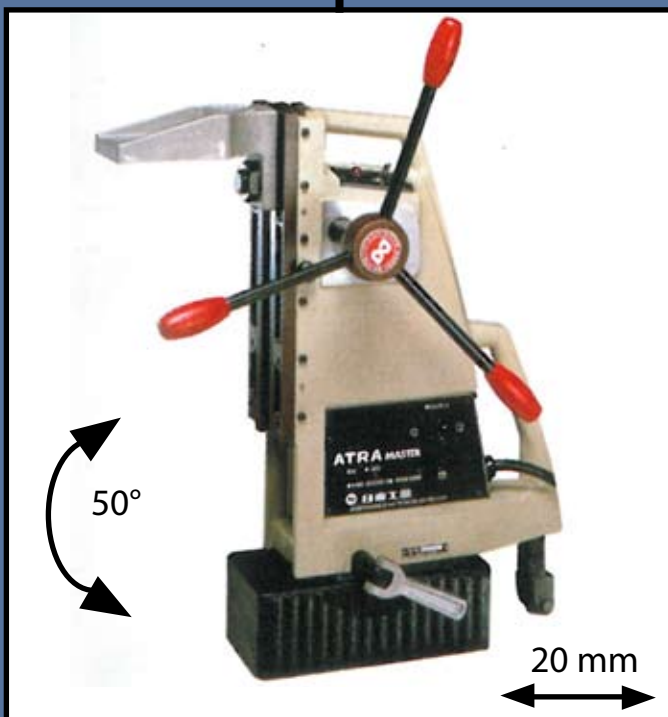

HAJO Varenummer: N1320

### Data:

Kap. spiralbor: 32 mm  
Slædevandring: 280 mm  
Mål (L)x(H)x(B) mm: 360 x 525 x 260  
Magnetholdekraft: 1.800 Kg  
Magnetfod mm.: 124 x 244 mm  
Vægt: 29,0 Kg  
Adapter beslag for din maskine kan leveres.  
1. Med 4 gears 1500 Watt højre/venstre  
boremaskine. MK3 DUSS DUD32-II RL  
2. Med 5 gears 1700 Watt højre/venstre  
boremaskine. Dr. Bender MK4 DBKR 550 M.

### Leverandør info:

HAJO TOOL A/S  
Vejlegårdsvej 65B  
2665 Vallensbæk Strand

Telefon: 44 44 24 00  
Fax: 44 44 08 33  
Web: www.hajo.dk



## Skæretabel

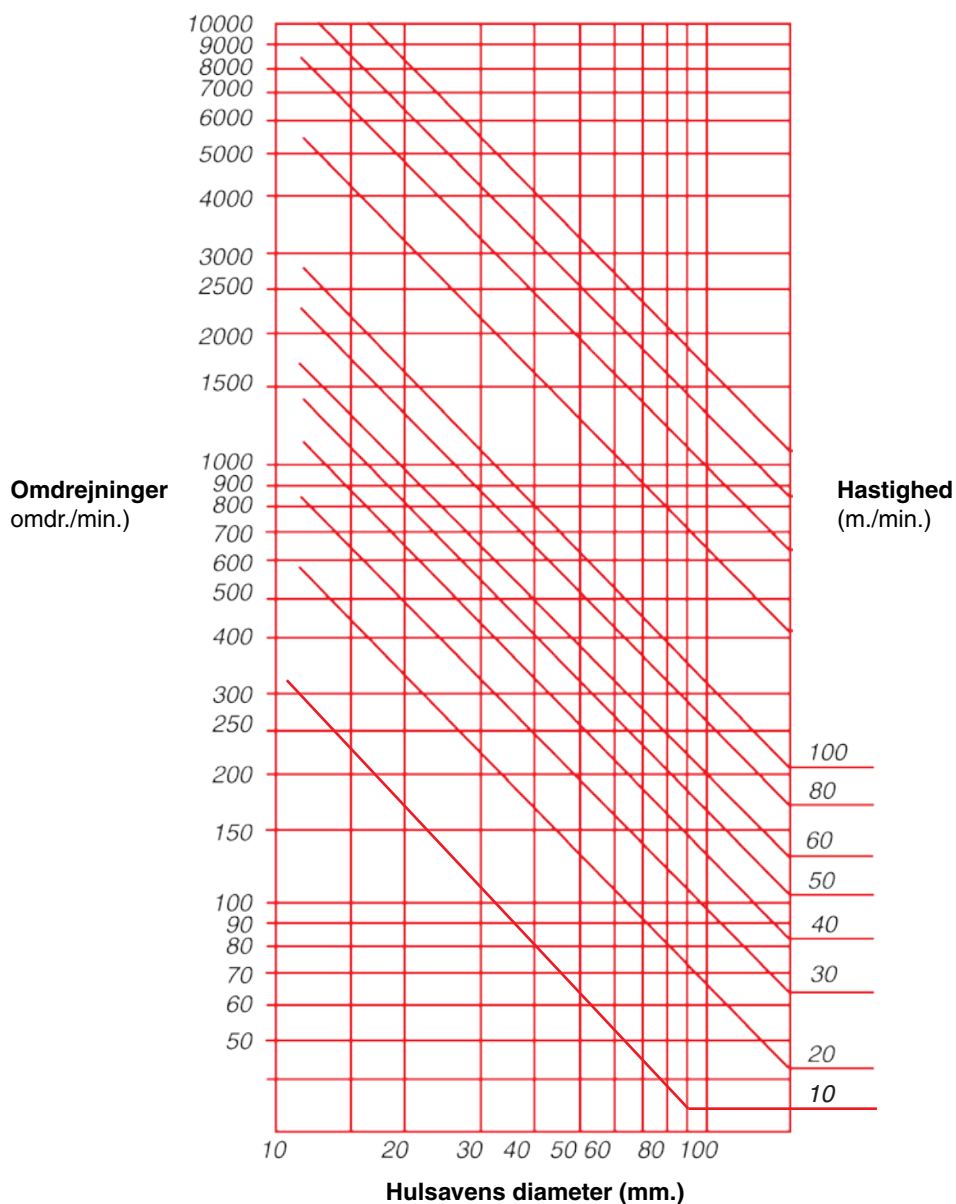

Hulsav type:	AHHS25xx	SHHSxxxx	NHHSxxxx	NJETxxxx
Materiale:				
Stål < 500N/mm <sup>2</sup>	30 mtr./min.	30 mtr./min.	30 mtr./min.	40-50 mtr./min.
Stål ≤ 850N/mm <sup>2</sup>	20 mtr./min.	20 mtr./min.	20 mtr./min.	30-40 mtr./min.
Rustfri stål	-----	-----	10 mtr./min.	20-30 mtr./min.
Aluminium	-----	-----	-----	70-90 mtr./min.
Støbejern	15 mtr./min.	15 mtr./min.	-----	30-50 mtr./min.
Messing	30 mtr./min.	30 mtr./min.	30 mtr./min.	50-70 mtr./min.
Tilspænding: 0,02 – 0,1 mm/omdr.				

# HAJO HIGH SPEED HULSAVE

SHHS hulsave med ONE-TOUCH og 19 mm (3/4") WELDON system.



## SHHS hulsave: 25 mm skæredybde

CENTERSPIDS

SHHS250677 Ø 6 x 77 MM

CENTERSPIDS

SHHS2512	Ø 12 MM	HIGHSPEED HULSAV
SHHS2513	Ø 13 MM	HIGHSPEED HULSAV
SHHS2514	Ø 14 MM	HIGHSPEED HULSAV
SHHS2515	Ø 15 MM	HIGHSPEED HULSAV
SHHS2516	Ø 16 MM	HIGHSPEED HULSAV
SHHS2517	Ø 17 MM	HIGHSPEED HULSAV
SHHS2518	Ø 18 MM	HIGHSPEED HULSAV
SHHS2519	Ø 19 MM	HIGHSPEED HULSAV
SHHS2520	Ø 20 MM	HIGHSPEED HULSAV
SHHS2521	Ø 21 MM	HIGHSPEED HULSAV
SHHS2522	Ø 22 MM	HIGHSPEED HULSAV
SHHS2523	Ø 23 MM	HIGHSPEED HULSAV
SHHS2524	Ø 24 MM	HIGHSPEED HULSAV
SHHS2525	Ø 25 MM	HIGHSPEED HULSAV
SHHS2526	Ø 26 MM	HIGHSPEED HULSAV
SHHS2527	Ø 27 MM	HIGHSPEED HULSAV
SHHS2528	Ø 28 MM	HIGHSPEED HULSAV
SHHS2529	Ø 29 MM	HIGHSPEED HULSAV
SHHS2530	Ø 30 MM	HIGHSPEED HULSAV
SHHS2531	Ø 31 MM	HIGHSPEED HULSAV
SHHS2532	Ø 32 MM	HIGHSPEED HULSAV
SHHS2533	Ø 33 MM	HIGHSPEED HULSAV
SHHS2534	Ø 34 MM	HIGHSPEED HULSAV
SHHS2535	Ø 35 MM	HIGHSPEED HULSAV
SHHS2536	Ø 36 MM	HIGHSPEED HULSAV
SHHS2537	Ø 37 MM	HIGHSPEED HULSAV
SHHS2538	Ø 38 MM	HIGHSPEED HULSAV
SHHS2539	Ø 39 MM	HIGHSPEED HULSAV
SHHS2540	Ø 40 MM	HIGHSPEED HULSAV
SHHS2541	Ø 41 MM	HIGHSPEED HULSAV
SHHS2542	Ø 42 MM	HIGHSPEED HULSAV
SHHS2543	Ø 43 MM	HIGHSPEED HULSAV
SHHS2544	Ø 44 MM	HIGHSPEED HULSAV
SHHS2545	Ø 45 MM	HIGHSPEED HULSAV
SHHS2546	Ø 46 MM	HIGHSPEED HULSAV
SHHS2547	Ø 47 MM	HIGHSPEED HULSAV
SHHS2548	Ø 48 MM	HIGHSPEED HULSAV
SHHS2549	Ø 49 MM	HIGHSPEED HULSAV
SHHS2550	Ø 50 MM	HIGHSPEED HULSAV
SHHS2551	Ø 51 MM	HIGHSPEED HULSAV
SHHS2552	Ø 52 MM	HIGHSPEED HULSAV
SHHS2553	Ø 53 MM	HIGHSPEED HULSAV
SHHS2554	Ø 54 MM	HIGHSPEED HULSAV
SHHS2555	Ø 55 MM	HIGHSPEED HULSAV
SHHS2556	Ø 56 MM	HIGHSPEED HULSAV
SHHS2557	Ø 57 MM	HIGHSPEED HULSAV
SHHS2558	Ø 58 MM	HIGHSPEED HULSAV
SHHS2559	Ø 59 MM	HIGHSPEED HULSAV
SHHS2560	Ø 60 MM	HIGHSPEED HULSAV

## SHHS hulsave: 50 mm skæredybde

CENTERSPIDS

SHHS5006102 Ø 6 x 102 MM

CENTERSPIDS

SHHS5014	Ø 14 MM	HIGHSPEED HULSAV
SHHS5015	Ø 15 MM	HIGHSPEED HULSAV
SHHS5016	Ø 16 MM	HIGHSPEED HULSAV
SHHS5017	Ø 17 MM	HIGHSPEED HULSAV
SHHS5018	Ø 18 MM	HIGHSPEED HULSAV
SHHS5019	Ø 19 MM	HIGHSPEED HULSAV
SHHS5020	Ø 20 MM	HIGHSPEED HULSAV
SHHS5021	Ø 21 MM	HIGHSPEED HULSAV
SHHS5022	Ø 22 MM	HIGHSPEED HULSAV
SHHS5023	Ø 23 MM	HIGHSPEED HULSAV
SHHS5024	Ø 24 MM	HIGHSPEED HULSAV
SHHS5025	Ø 25 MM	HIGHSPEED HULSAV
SHHS5026	Ø 26 MM	HIGHSPEED HULSAV
SHHS5027	Ø 27 MM	HIGHSPEED HULSAV
SHHS5028	Ø 28 MM	HIGHSPEED HULSAV
SHHS5029	Ø 29 MM	HIGHSPEED HULSAV
SHHS5030	Ø 30 MM	HIGHSPEED HULSAV
SHHS5031	Ø 31 MM	HIGHSPEED HULSAV
SHHS5032	Ø 32 MM	HIGHSPEED HULSAV
SHHS5033	Ø 33 MM	HIGHSPEED HULSAV
SHHS5034	Ø 34 MM	HIGHSPEED HULSAV
SHHS5035	Ø 35 MM	HIGHSPEED HULSAV
SHHS5036	Ø 36 MM	HIGHSPEED HULSAV
SHHS5037	Ø 37 MM	HIGHSPEED HULSAV
SHHS5038	Ø 38 MM	HIGHSPEED HULSAV
SHHS5039	Ø 39 MM	HIGHSPEED HULSAV
SHHS5040	Ø 40 MM	HIGHSPEED HULSAV
SHHS5041	Ø 41 MM	HIGHSPEED HULSAV
SHHS5042	Ø 42 MM	HIGHSPEED HULSAV
SHHS5043	Ø 43 MM	HIGHSPEED HULSAV
SHHS5044	Ø 44 MM	HIGHSPEED HULSAV
SHHS5045	Ø 45 MM	HIGHSPEED HULSAV
SHHS5046	Ø 46 MM	HIGHSPEED HULSAV
SHHS5047	Ø 47 MM	HIGHSPEED HULSAV
SHHS5048	Ø 48 MM	HIGHSPEED HULSAV
SHHS5049	Ø 49 MM	HIGHSPEED HULSAV
SHHS5050	Ø 50 MM	HIGHSPEED HULSAV
SHHS5051	Ø 51 MM	HIGHSPEED HULSAV
SHHS5052	Ø 52 MM	HIGHSPEED HULSAV
SHHS5053	Ø 53 MM	HIGHSPEED HULSAV
SHHS5054	Ø 54 MM	HIGHSPEED HULSAV
SHHS5055	Ø 55 MM	HIGHSPEED HULSAV
SHHS5056	Ø 56 MM	HIGHSPEED HULSAV
SHHS5057	Ø 57 MM	HIGHSPEED HULSAV
SHHS5058	Ø 58 MM	HIGHSPEED HULSAV
SHHS5059	Ø 59 MM	HIGHSPEED HULSAV
SHHS5060	Ø 60 MM	HIGHSPEED HULSAV

### Leverandør info:

HAJO TOOL A/S  
Vejlegårdsvej 65B  
2665 Vallensbæk Strand

Telefon: 44 44 24 00  
Fax: 44 44 08 33  
Web: [www.hajo.dk](http://www.hajo.dk)



110 mm skæredybde  
og centerspids  
Se også ----->



# HAJO HIGH SPEED HULSAV

SHHS hulsav med ONE-TOUCH og 19 mm (3/4") WELDON system.



## SHHS hulsav: 110 mm skæredybde

SHHS11008160 CENTERSPIDS Ø 8 x 160 MM	SHHS11020	Ø 20 MM	HIGHSPEED HULSAV
	SHHS11022	Ø 22 MM	HIGHSPEED HULSAV
	SHHS11024	Ø 24 MM	HIGHSPEED HULSAV
	SHHS11025	Ø 25 MM	HIGHSPEED HULSAV
	SHHS11026	Ø 26 MM	HIGHSPEED HULSAV
	SHHS11028	Ø 28 MM	HIGHSPEED HULSAV
	SHHS11030	Ø 30 MM	HIGHSPEED HULSAV
	SHHS11032	Ø 32 MM	HIGHSPEED HULSAV
	SHHS11034	Ø 34 MM	HIGHSPEED HULSAV
	SHHS11035	Ø 35 MM	HIGHSPEED HULSAV
	SHHS11040	Ø 40 MM	HIGHSPEED HULSAV
	SHHS11042	Ø 42 MM	HIGHSPEED HULSAV
	SHHS11045	Ø 45 MM	HIGHSPEED HULSAV
	SHHS11050	Ø 50 MM	HIGHSPEED HULSAV

## Centerspids til 25 mm skæredybde

SHHS250677 Ø 6 x 77 MM

## Centerspids til 50 mm skæredybde

SHHS5006102 Ø 6 x 102 MM

## Centerspids til 110 mm skæredybde

SHHS11008160 Ø 8 x 160 MM



### Leverandør info:

HAJO TOOL A/S  
Vejlegårdsvej 65B  
2665 Vallensbæk Strand

Telefon: 44 44 24 00  
Fax: 44 44 08 33  
Web: www.hajo.dk



25 mm skæredybde  
50 mm skæredybde  
Se også ----->

A

# NITTO HIBROACH HSS HULSAVE

MED ONE-TOUCH LYN-BAJONET SYSTEM  
OG 19 mm (3/4") WELDON SKAFT.



## NHHS hulsave: 25 mm kopdybde

NHHS250677 Ø 6 x 77 MM

CENTERSPIDS

NHHS250891 Ø 8 x 91 MM

NHHS2512	Ø 12 MM	HIGHSPEED HULSAV
NHHS2513	Ø 13 MM	HIGHSPEED HULSAV
NHHS2514	Ø 14 MM	HIGHSPEED HULSAV
NHHS2515	Ø 15 MM	HIGHSPEED HULSAV
NHHS2516	Ø 16 MM	HIGHSPEED HULSAV
NHHS2517	Ø 17 MM	HIGHSPEED HULSAV
NHHS2518	Ø 18 MM	HIGHSPEED HULSAV
NHHS2519	Ø 19 MM	HIGHSPEED HULSAV
NHHS2520	Ø 20 MM	HIGHSPEED HULSAV
NHHS2521	Ø 21 MM	HIGHSPEED HULSAV
NHHS2522	Ø 22 MM	HIGHSPEED HULSAV
NHHS2523	Ø 23 MM	HIGHSPEED HULSAV
NHHS2524	Ø 24 MM	HIGHSPEED HULSAV
NHHS2525	Ø 25 MM	HIGHSPEED HULSAV
NHHS2526	Ø 26 MM	HIGHSPEED HULSAV
NHHS2527	Ø 27 MM	HIGHSPEED HULSAV
NHHS2528	Ø 28 MM	HIGHSPEED HULSAV
NHHS2529	Ø 29 MM	HIGHSPEED HULSAV
NHHS2530	Ø 30 MM	HIGHSPEED HULSAV
NHHS2531	Ø 31 MM	HIGHSPEED HULSAV
NHHS2532	Ø 32 MM	HIGHSPEED HULSAV
NHHS2533	Ø 33 MM	HIGHSPEED HULSAV
NHHS2534	Ø 34 MM	HIGHSPEED HULSAV
NHHS2535	Ø 35 MM	HIGHSPEED HULSAV
NHHS2536	Ø 36 MM	HIGHSPEED HULSAV
NHHS2537	Ø 37 MM	HIGHSPEED HULSAV
NHHS2538	Ø 38 MM	HIGHSPEED HULSAV
NHHS2539	Ø 39 MM	HIGHSPEED HULSAV
NHHS2540	Ø 40 MM	HIGHSPEED HULSAV
NHHS2541	Ø 41 MM	HIGHSPEED HULSAV
NHHS2542	Ø 42 MM	HIGHSPEED HULSAV
NHHS2543	Ø 43 MM	HIGHSPEED HULSAV
NHHS2544	Ø 44 MM	HIGHSPEED HULSAV
NHHS2545	Ø 45 MM	HIGHSPEED HULSAV
NHHS2546	Ø 46 MM	HIGHSPEED HULSAV
NHHS2547	Ø 47 MM	HIGHSPEED HULSAV
NHHS2548	Ø 48 MM	HIGHSPEED HULSAV
NHHS2549	Ø 49 MM	HIGHSPEED HULSAV
NHHS2550	Ø 50 MM	HIGHSPEED HULSAV
NHHS2551	Ø 51 MM	HIGHSPEED HULSAV
NHHS2552	Ø 52 MM	HIGHSPEED HULSAV

## NHHS hulsave: 50 mm kopdybde

NHHS5006102 Ø 6 x 102 MM

CENTERSPIDS

NHHS5008102 Ø 8 x 102 MM

NHHS5012	Ø 12 MM	HIGHSPEED HULSAV
NHHS5013	Ø 13 MM	HIGHSPEED HULSAV
NHHS5014	Ø 14 MM	HIGHSPEED HULSAV
NHHS5015	Ø 15 MM	HIGHSPEED HULSAV
NHHS5016	Ø 16 MM	HIGHSPEED HULSAV
NHHS5017	Ø 17 MM	HIGHSPEED HULSAV
NHHS5018	Ø 18 MM	HIGHSPEED HULSAV
NHHS5019	Ø 19 MM	HIGHSPEED HULSAV
NHHS2520	Ø 20 MM	HIGHSPEED HULSAV
NHHS5021	Ø 21 MM	HIGHSPEED HULSAV
NHHS5022	Ø 22 MM	HIGHSPEED HULSAV
NHHS5023	Ø 23 MM	HIGHSPEED HULSAV
NHHS5024	Ø 24 MM	HIGHSPEED HULSAV
NHHS5025	Ø 25 MM	HIGHSPEED HULSAV
NHHS5026	Ø 26 MM	HIGHSPEED HULSAV
NHHS5027	Ø 27 MM	HIGHSPEED HULSAV
NHHS5028	Ø 28 MM	HIGHSPEED HULSAV
NHHS5029	Ø 29 MM	HIGHSPEED HULSAV
NHHS5030	Ø 30 MM	HIGHSPEED HULSAV
NHHS5031	Ø 31 MM	HIGHSPEED HULSAV
NHHS5032	Ø 32 MM	HIGHSPEED HULSAV
NHHS5033	Ø 33 MM	HIGHSPEED HULSAV
NHHS5034	Ø 34 MM	HIGHSPEED HULSAV
NHHS5035	Ø 35 MM	HIGHSPEED HULSAV
NHHS5036	Ø 36 MM	HIGHSPEED HULSAV
NHHS5037	Ø 37 MM	HIGHSPEED HULSAV
NHHS5038	Ø 38 MM	HIGHSPEED HULSAV
NHHS5039	Ø 39 MM	HIGHSPEED HULSAV
NHHS5040	Ø 40 MM	HIGHSPEED HULSAV
NHHS5041	Ø 41 MM	HIGHSPEED HULSAV
NHHS5042	Ø 42 MM	HIGHSPEED HULSAV
NHHS5043	Ø 43 MM	HIGHSPEED HULSAV
NHHS5044	Ø 44 MM	HIGHSPEED HULSAV
NHHS5045	Ø 45 MM	HIGHSPEED HULSAV
NHHS5046	Ø 46 MM	HIGHSPEED HULSAV
NHHS5047	Ø 47 MM	HIGHSPEED HULSAV
NHHS5048	Ø 48 MM	HIGHSPEED HULSAV
NHHS5049	Ø 49 MM	HIGHSPEED HULSAV
NHHS5050	Ø 50 MM	HIGHSPEED HULSAV
NHHS5051	Ø 51 MM	HIGHSPEED HULSAV
NHHS5052	Ø 52 MM	HIGHSPEED HULSAV



HAJO TOOL A/S  
Vejlegårdsvej 65B  
2665 Vallensbæk Str.

Tlf.: 44 44 24 00  
Fax: 44 44 08 33  
Web: www.hajo.dk

# HAJO UNIVERSAL PLADEHULSAVE

## MED HÅRDMETAL PLATTER - MY278U

12 mm skæredybde



### HAJO universal HM pladehulsav

MY278U15	Ø 15 MM	HAJO HM PLADEHULSAV
MY278U16	Ø 16 MM	HAJO HM PLADEHULSAV
MY278U17	Ø 17 MM	HAJO HM PLADEHULSAV
MY278U18	Ø 18 MM	HAJO HM PLADEHULSAV
MY278U19	Ø 19 MM	HAJO HM PLADEHULSAV
MY278U20	Ø 20 MM	HAJO HM PLADEHULSAV
MY278U21	Ø 21 MM	HAJO HM PLADEHULSAV
MY278U22	Ø 22 MM	HAJO HM PLADEHULSAV
MY278U23	Ø 23 MM	HAJO HM PLADEHULSAV
MY278U24	Ø 24 MM	HAJO HM PLADEHULSAV
MY278U25	Ø 25 MM	HAJO HM PLADEHULSAV
MY278U26	Ø 26 MM	HAJO HM PLADEHULSAV
MY278U27	Ø 27 MM	HAJO HM PLADEHULSAV
MY278U28	Ø 28 MM	HAJO HM PLADEHULSAV
MY278U29	Ø 29 MM	HAJO HM PLADEHULSAV
MY278U30	Ø 30 MM	HAJO HM PLADEHULSAV
MY278U31	Ø 31 MM	HAJO HM PLADEHULSAV
MY278U32	Ø 32 MM	HAJO HM PLADEHULSAV
MY278U33	Ø 33 MM	HAJO HM PLADEHULSAV
MY278U34	Ø 34 MM	HAJO HM PLADEHULSAV
MY278U35	Ø 35 MM	HAJO HM PLADEHULSAV
MY278U36	Ø 36 MM	HAJO HM PLADEHULSAV
MY278U37	Ø 37 MM	HAJO HM PLADEHULSAV
MY278U38	Ø 38 MM	HAJO HM PLADEHULSAV
MY278U39	Ø 39 MM	HAJO HM PLADEHULSAV
MY278U40	Ø 40 MM	HAJO HM PLADEHULSAV
MY278U41	Ø 41 MM	HAJO HM PLADEHULSAV
MY278U42	Ø 42 MM	HAJO HM PLADEHULSAV
MY278U43	Ø 43 MM	HAJO HM PLADEHULSAV
MY278U44	Ø 44 MM	HAJO HM PLADEHULSAV
MY278U45	Ø 45 MM	HAJO HM PLADEHULSAV
MY278U46	Ø 46 MM	HAJO HM PLADEHULSAV
MY278U47	Ø 47 MM	HAJO HM PLADEHULSAV
MY278U48	Ø 48 MM	HAJO HM PLADEHULSAV
MY278U49	Ø 49 MM	HAJO HM PLADEHULSAV
MY278U50	Ø 50 MM	HAJO HM PLADEHULSAV
MY278U51	Ø 51 MM	HAJO HM PLADEHULSAV
MY278U52	Ø 52 MM	HAJO HM PLADEHULSAV
MY278U53	Ø 53 MM	HAJO HM PLADEHULSAV
MY278U54	Ø 54 MM	HAJO HM PLADEHULSAV
MY278U55	Ø 55 MM	HAJO HM PLADEHULSAV
MY278U56	Ø 56 MM	HAJO HM PLADEHULSAV
MY278U57	Ø 57 MM	HAJO HM PLADEHULSAV
MY278U58	Ø 58 MM	HAJO HM PLADEHULSAV
MY278U59	Ø 59 MM	HAJO HM PLADEHULSAV
MY278U60	Ø 60 MM	HAJO HM PLADEHULSAV
MY278U61	Ø 61 MM	HAJO HM PLADEHULSAV

### HAJO universal HM pladehulsav

MY278U62	Ø 62 MM	HAJO HM PLADEHULSAV
MY278U63	Ø 63 MM	HAJO HM PLADEHULSAV
MY278U64	Ø 64 MM	HAJO HM PLADEHULSAV
MY278U65	Ø 65 MM	HAJO HM PLADEHULSAV
MY278U66	Ø 66 MM	HAJO HM PLADEHULSAV
MY278U67	Ø 67 MM	HAJO HM PLADEHULSAV
MY278U68	Ø 68 MM	HAJO HM PLADEHULSAV
MY278U69	Ø 69 MM	HAJO HM PLADEHULSAV
MY278U70	Ø 70 MM	HAJO HM PLADEHULSAV
MY278U71	Ø 71 MM	HAJO HM PLADEHULSAV
MY278U72	Ø 72 MM	HAJO HM PLADEHULSAV
MY278U73	Ø 73 MM	HAJO HM PLADEHULSAV
MY278U74	Ø 74 MM	HAJO HM PLADEHULSAV
MY278U75	Ø 75 MM	HAJO HM PLADEHULSAV
MY278U76	Ø 76 MM	HAJO HM PLADEHULSAV
MY278U77	Ø 77 MM	HAJO HM PLADEHULSAV
MY278U78	Ø 78 MM	HAJO HM PLADEHULSAV
MY278U79	Ø 79 MM	HAJO HM PLADEHULSAV
MY278U80	Ø 80 MM	HAJO HM PLADEHULSAV
MY278U81	Ø 81 MM	HAJO HM PLADEHULSAV
MY278U82	Ø 82 MM	HAJO HM PLADEHULSAV
MY278U83	Ø 83 MM	HAJO HM PLADEHULSAV
MY278U84	Ø 84 MM	HAJO HM PLADEHULSAV
MY278U85	Ø 85 MM	HAJO HM PLADEHULSAV
MY278U86	Ø 86 MM	HAJO HM PLADEHULSAV
MY278U87	Ø 87 MM	HAJO HM PLADEHULSAV
MY278U88	Ø 88 MM	HAJO HM PLADEHULSAV
MY278U89	Ø 89 MM	HAJO HM PLADEHULSAV
MY278U90	Ø 90 MM	HAJO HM PLADEHULSAV
MY278U91	Ø 91 MM	HAJO HM PLADEHULSAV
MY278U92	Ø 92 MM	HAJO HM PLADEHULSAV
MY278U93	Ø 93 MM	HAJO HM PLADEHULSAV
MY278U94	Ø 94 MM	HAJO HM PLADEHULSAV
MY278U95	Ø 95 MM	HAJO HM PLADEHULSAV
MY278U96	Ø 96 MM	HAJO HM PLADEHULSAV
MY278U97	Ø 97 MM	HAJO HM PLADEHULSAV
MY278U98	Ø 98 MM	HAJO HM PLADEHULSAV
MY278U99	Ø 99 MM	HAJO HM PLADEHULSAV
MY278U100	Ø 100 MM	HAJO HM PLADEHULSAV
*MY278U105	Ø 105 MM	HAJO HM PLADEHULSAV
*MY278U110	Ø 110 MM	HAJO HM PLADEHULSAV
*MY278U115	Ø 115 MM	HAJO HM PLADEHULSAV
*MY278U120	Ø 120 MM	HAJO HM PLADEHULSAV
*MY278U125	Ø 125 MM	HAJO HM PLADEHULSAV
*MY278U130	Ø 130 MM	HAJO HM PLADEHULSAV
*MY278U135	Ø 135 MM	HAJO HM PLADEHULSAV
*MY278U140	Ø 140 MM	HAJO HM PLADEHULSAV
*MY278U145	Ø 145 MM	HAJO HM PLADEHULSAV
*MY278U150	Ø 150 MM	HAJO HM PLADEHULSAV



HAJO TOOL A/S  
Vejlegårdsvej 65B  
2665 Vallensbæk Str.

Tlf.: 44 44 24 00  
Fax: 44 44 08 33  
Web: www.hajo.dk

### CENTERBOR F/ MY278U

MY278UC HAJO CENTERBOR Ø 6 X 60 MM  
\*MY2788C HAJO CENTERBOR Ø 8 X 61 MM  
(\*TIL MY278U HULSAVE FRA Ø 105 - 150 MM)

# NITTO JETBROACH HULSAVE

HULSAVE MED HÅRDMETAL PLATTER  
ONE-TOUCH LYN-BAJONET  
19 mm (3/4") WELDON SKAFT



## NJET hulsave: 35 mm skæredybde

NJET350891 Ø 8 X 91 MM

CENTERSPIDS

NJET35175	Ø 17,5	
NJET3518	Ø 18	
NJET3519	Ø 19	
NJET35195	Ø 19,5	NYHED!
NJET3520	Ø 20	
NJET35205	Ø 20,5	NYHED!
NJET3521	Ø 21	
NJET35215	Ø 21,5	
NJET3522	Ø 22	
NJET35225	Ø 22,5	NYHED!
NJET3523	Ø 23	
NJET35235	Ø 23,5	NYHED!
NJET3524	Ø 24	
NJET35245	Ø 24,5	
NJET3525	Ø 25	
NJET3526	Ø 26	
NJET3527	Ø 27	
NJET3528	Ø 28	
NJET3529	Ø 29	
NJET3530	Ø 30	
NJET3531	Ø 31	
NJET3532	Ø 32	
NJET3533	Ø 33	
NJET3534	Ø 34	
NJET3535	Ø 35	
NJET3536	Ø 36	NYHED!
NJET3537	Ø 37	NYHED!
NJET3538	Ø 38	NYHED!
NJET3539	Ø 39	NYHED!
NJET3540	Ø 40	NYHED!

DEM DER REGNER PRISEN UD PR. BORET HUL:  
DE BRUGER NITTOS MAGNETBOREMASKINER MED  
AUTOMATISK TILSPÆNDNING + NJET HULSAVE.

## NJET hulsave: 50 mm skæredybde

NJET5008102 Ø 8 X 102 MM

NJET50175	Ø 17,5	
NJET5018	Ø 18	
NJET5019	Ø 19	
NJET50195	Ø 19,5	NYHED!
NJET5020	Ø 20	
NJET50205	Ø 20,5	NYHED!
NJET5021	Ø 21	
NJET50215	Ø 21,5	
NJET5022	Ø 22	
NJET50225	Ø 22,5	NYHED!
NJET5023	Ø 23	

NJET50235	Ø 23,5	NYHED!
NJET5024	Ø 24	
NJET50245	Ø 24,5	
NJET5025	Ø 25	
NJET5026	Ø 26	
NJET50265	Ø 26,5	NYHED!
NJET5027	Ø 27	
NJET5028	Ø 28	
NJET5029	Ø 29	
NJET5030	Ø 30	
NJET5031	Ø 31	
NJET5032	Ø 32	
NJET5033	Ø 33	
NJET5034	Ø 34	
NJET5035	Ø 35	
NJET5036	Ø 36	
NJET5037	Ø 37	
NJET5038	Ø 38	
NJET5039	Ø 39	
NJET5040	Ø 40	
NJET5041	Ø 41	
NJET5042	Ø 42	
NJET5043	Ø 43	
NJET5044	Ø 44	
NJET5045	Ø 45	
NJET5046	Ø 46	
NJET5047	Ø 47	
NJET5048	Ø 48	
NJET5049	Ø 49	
NJET5050	Ø 50	
NJET5051	Ø 51	
NJET5052	Ø 52	
NJET5053	Ø 53	
NJET5054	Ø 54	
NJET5055	Ø 55	
NJET5056	Ø 56	
NJET5057	Ø 57	
NJET5058	Ø 58	
NJET5059	Ø 59	
NJET5060	Ø 60	
NJET5061	Ø 61	
NJET5062	Ø 62	
NJET5063	Ø 63	
NJET5064	Ø 64	
NJET5065	Ø 65	

NJET5008102 Ø 8 X 102 MM

CENTERSPIDS

EFFEKTIV BEARBEJDNING PÅ SØJLEBOREMASKINE

MK2 HOLDER Ø12 - Ø35 MM. NBHM 2035  
MK3 HOLDER Ø12 - Ø52 MM. NBHM 3050



HAJO TOOL A/S  
Vejlegårdsvej 65B  
2665 Vallensbæk Str.

Tlf.: 44 44 24 00  
Fax: 44 44 08 33  
Web: www.hajo.dk

A



# NITTO JETBROACH HULSAVE

HULSAVE MED HÅRDMETAL PLATTER



ONE-TOUCH LYN-BAJONET  
SKAFT & 19 mm (3/4") WELDON

32 mm (1 1/4") WELDON

## NJET hulsave: 75 mm skæredybde

CENTERSPIDS

NJET7508133 Ø 8 X 133 MM

NJET75175	Ø 17,5	NYHED!
NJET7518	Ø 18	
NJET7519	Ø 19	
NJET7520	Ø 20	
NJET7521	Ø 21	
NJET7522	Ø 22	
NJET7523	Ø 23	
NJET7524	Ø 24	
NJET7525	Ø 25	
NJET7526	Ø 26	
NJET7527	Ø 27	
NJET7528	Ø 28	
NJET7529	Ø 29	
NJET7530	Ø 30	
NJET7531	Ø 31	
NJET7532	Ø 32	
NJET7533	Ø 33	
NJET7534	Ø 34	
NJET7535	Ø 35	
NJET7536	Ø 36	
NJET7537	Ø 37	
NJET7538	Ø 38	
NJET7539	Ø 39	
NJET7540	Ø 40	
NJET7541	Ø 41	
NJET7542	Ø 42	
NJET7543	Ø 43	
NJET7544	Ø 44	
NJET7545	Ø 45	
NJET7546	Ø 46	
NJET7547	Ø 47	
NJET7548	Ø 48	
NJET7549	Ø 49	
NJET7550	Ø 50	
NJET7551	Ø 51	NYHED!
NJET7552	Ø 52	NYHED!
NJET7553	Ø 53	NYHED!
NJET7554	Ø 54	NYHED!
NJET7555	Ø 55	NYHED!

DEM DER REGNER PRISEN UD PR. BORET HUL:  
DE BRUGER NITTOS MAGNETBOREMASKINER MED  
AUTOMATISK TILSPÆNDNING + NJET HULSAVE.



HAJO TOOL A/S Tlf.: 44 44 24 00  
Vejlegårdsvej 65B Fax: 44 44 08 33  
2665 Vallensbæk Str. Web: www.hajo.dk

## NJET hulsave: 75 mm skæredybde

CENTERSPIDS

NJETW751206190 Ø 12 / 6 X 190 MM

NJETW7550	Ø 50	NYHED!
NJETW7551	Ø 51	
NJETW7552	Ø 52	
NJETW7553	Ø 53	
NJETW7554	Ø 54	
NJETW7555	Ø 55	
NJETW7556	Ø 56	
NJETW7557	Ø 57	
NJETW7558	Ø 58	
NJETW7559	Ø 59	
NJETW7560	Ø 60	
NJETW7561	Ø 61	
NJETW7562	Ø 62	
NJETW7563	Ø 63	
NJETW7564	Ø 64	
NJETW7565	Ø 65	
NJETW7566	Ø 66	
NJETW7567	Ø 67	
NJETW7568	Ø 68	
NJETW7569	Ø 69	
NJETW7570	Ø 70	
NJETW7571	Ø 71	
NJETW7572	Ø 72	
NJETW7573	Ø 73	
NJETW7574	Ø 74	
NJETW7575	Ø 75	
NJETW7576	Ø 76	
NJETW7577	Ø 77	
NJETW7578	Ø 78	
NJETW7579	Ø 79	
NJETW7580	Ø 80	
NJETW7581	Ø 81	
NJETW7582	Ø 82	
NJETW7583	Ø 83	
NJETW7584	Ø 84	
NJETW7585	Ø 85	
NJETW7586	Ø 86	
NJETW7587	Ø 87	
NJETW7588	Ø 88	
NJETW7589	Ø 89	
NJETW7590	Ø 90	
NJETW7591	Ø 91	
NJETW7592	Ø 92	
NJETW7593	Ø 93	
NJETW7594	Ø 94	
NJETW7595	Ø 95	
NJETW7596	Ø 96	
NJETW7597	Ø 97	
NJETW7598	Ø 98	
NJETW7599	Ø 99	
NJETW75100	Ø 100	

EFFEKTIV BEARBEJDNING PÅ SØJLEBOREMASKINE

MK3 HOLDER Ø50 - Ø75 MM. NBHM 3075  
MK4 HOLDER Ø50 - Ø100 MM. NBHM 4075

CENTERSPIDS NJET W 751206190



# VAKUUMSTANDER

## Letvægts Vakuumstander

-Med højdejustering og mulighed for boring med hulsavbor.

# Manuel

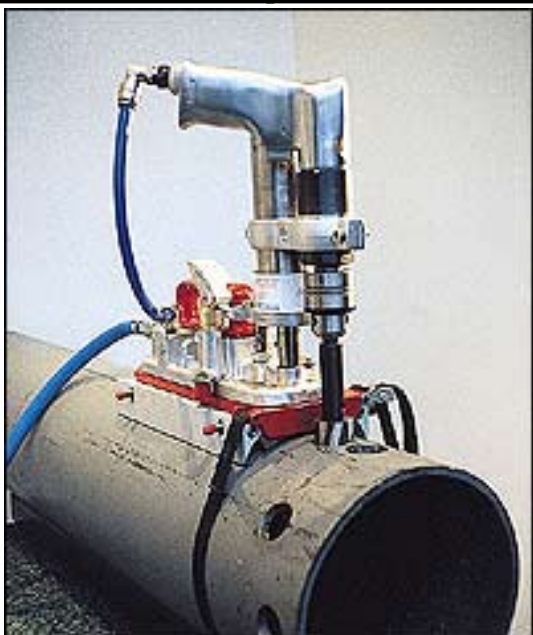

### Røranlæg DMDSCA100

Passer til: Magnetboremaskiner  
Rørdiameter: Ø 150 mm - Ø 1500 mm  
Vægt: 8.0 Kg .



### VAC FORCE 2000



Arbejder du i rustfrit stål og savner du den fordel, man har ved at bruge magnetboremaskine, så kan vi hjælpe dig med en vakuumplade til at anbringe din magnetboremaskine på eller vi kan levere en vakuumplade inkl. boremaskine med tilspændingshåndtag. Fortæl os om din opgave og vi kommer med løsningen.



### Vakuumstander VAC-FORCE 2000

Højde: 280 mm  
Længde: 280 mm  
Bredde: 89 mm  
Rørfiksering:  
min. Ø 600 mm  
Anlæg kan fås fra:  
Ø 50 mm (DMPV2000)  
Vægt: 4.5 Kg.

### Leverandør info:

HAJO TOOL A/S  
Vejlegårdsvej 65B  
2665 Vallensbæk Strand

Telefon: 44 44 24 00  
Fax: 44 44 08 33  
Web: www.hajo.dk



## Der er mange muligheder med Nitto magnetboremaskiner

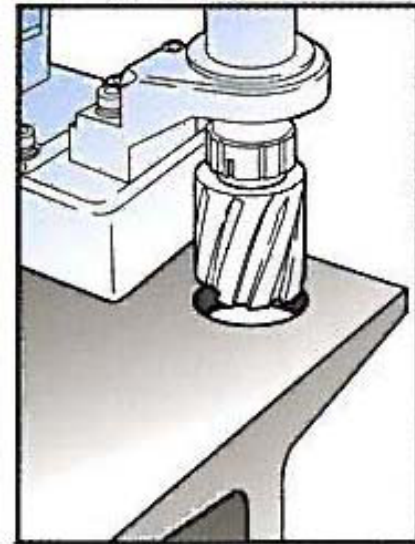

Boring med skæv udgang

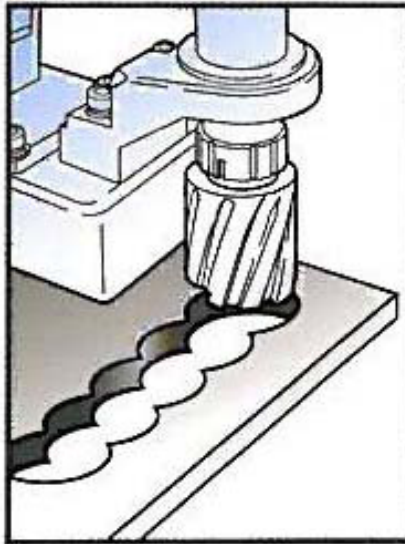

Overlappet boring

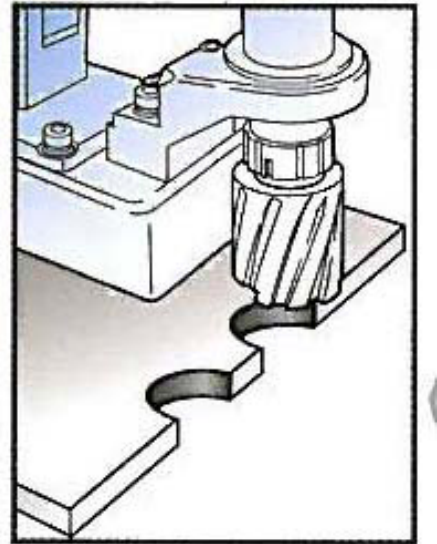

Boring i kant (halve huller)



Lynkobling uden brug af værktøj.





# HAJO TOOL

Professionelt specialværktøj

Vejlegårdsvej 65 B  
2665 Vallensbæk Strand  
Tlf.: 4444 2400 [www.hajo.dk](http://www.hajo.dk)  
Fax. 4444 0833 [hajo@hajo.dk](mailto:hajo@hajo.dk)